

# Microlab<sup>®</sup> 600 Basic Manual

## Hardware Installation and Basic Operation



Distributed by:

**Lab Unlimited**  
CARL STUART GROUP

Tallaght Business Park  
Whitestown, Dublin 24,  
Ireland  
D24 RFK3

Tel: (01) 4523432  
Fax: (01) 4523967  
E-mail: [info@labunlimited.com](mailto:info@labunlimited.com)  
Web: [www.labunlimited.com](http://www.labunlimited.com)

Quatro House, Frimley Road,  
Camberley,  
United Kingdom  
GU16 7ER

Tel: 08452 30 40 30  
Fax: 08452 30 50 30  
E-mail: [info@labunlimited.co.uk](mailto:info@labunlimited.co.uk)  
Web: [www.labunlimited.co.uk](http://www.labunlimited.co.uk)

# Warranty Information

Hamilton Company warrants this equipment<sup>1</sup> to be free of defects in material and workmanship for 12 months from the date of receipt. The warranty does not cover normal wear and tear of the syringes, valves or equipment. The warranty is extended to the buyer of record on the original purchase order to Hamilton Company. Hamilton Company or an authorized Hamilton representative agrees to repair or replace, at its option and free of charge to the buyer at a normal place of business or at a Hamilton repair facility, any part or parts that under proper and normal use prove to be defective during the warranty period.<sup>2</sup> Abuse, unauthorized replacement of parts, modifications or adjustments made by other than Hamilton Company or its assigned representative voids this warranty.

This warranty gives you specific rights. No other warranties, expressed or implied, including implications of warranties of merchantability and fitness for a particular product, are made. Hamilton Company's liability on the sale of all products shall be limited to repair, replacement or refund of price of any defective product.<sup>2</sup>

Hamilton Company endeavors to provide prompt and satisfactory service.

*1—All Hamilton Company valves are warranted to be free of defects in material and workmanship at the time of delivery.*

*2—Hamilton Company reserves the right to refuse to accept the return of any instrument or valve that has been used with radioactive, microbiological substances or any other material that may be deemed hazardous to employees of Hamilton Company.*

©2013 Hamilton Company. All rights reserved.

Microsoft, Windows, Visual Studio, Visual C# and Visual Basic are registered trademarks of Microsoft Corporation in the United States and other countries.

LabVIEW is a trademark of National Instruments. Neither Hamilton Company, nor any software programs or other goods or services offered by Hamilton Company, are affiliated with, endorsed by or sponsored by National Instruments.

All other trademarks are owned and/or registered by Hamilton Company in the U.S. and/or other countries.



Copyright © 1994–2008 Lua.org, PUC-Rio.





# Instruction to the User

This equipment has been tested and found to comply with the limits for a class B digital device, pursuant to Part 15, Federal Communication Commission (FCC) Rules. These limits are designed to provide reasonable protection against harmful interference in an installation. This equipment generates, uses and can radiate radio frequency energy, and if not installed and used in accordance with the instructions, may cause harmful interference to radio communications. However, there is no guarantee that interference will not occur in a particular installation. If this equipment does cause harmful interference to radio or television reception, which can be determined by turning the equipment off and on, the user is encouraged to try to correct the interference by one or more of the following measures:

- ▶ **Turn the Microlab® 600 Off and On to determine whether it is generating interference.**
- ▶ **Reorient or relocate the receiving antenna.**
- ▶ **Increase the separation between the equipment and receiver.**
- ▶ **Connect the equipment into an outlet on a circuit different from that to which the receiver is connected.**
- ▶ **Consult the dealer or an experienced radio/TV technician for help.**

This equipment has been verified to comply with the limits for a class B computing device, pursuant to FCC Rules. In order to maintain compliance with the FCC regulations, shielded cables must be used with this equipment. Operation with non-approved equipment or unshielded cables is likely to result in interference to radio and TV reception. The user is cautioned that changes and modifications made to the equipment without the approval of the manufacturer could void the user's authority to operate this equipment.





# Table of Contents

<b>Warranty Information</b> .....	<b>i</b>
<b>Instruction to the User</b> .....	<b>iii</b>
<b>Welcome</b> .....	<b>1</b>
<b>Intended Use</b> .....	<b>3</b>
<b>About the Microlab® 600 Manuals</b> .....	<b>5</b>
Basic Microlab 600 Manual .....	<b>5</b>
Advanced Microlab 600 Manual .....	<b>5</b>
Computer Controlled Microlab 600 Manual .....	<b>5</b>
<b>Conventions Used in this Manual</b> .....	<b>7</b>
<b>Chapter 1: Introduction</b> .....	<b>1-1</b>
<b>1.1</b> Introduction of the Microlab 600 .....	<b>1-2</b>
<b>1.2</b> Microlab 600 Part Number Nomenclature .....	<b>1-2</b>
<b>1.3</b> Microlab 600 Hardware Setups .....	<b>1-3</b>
<b>1.3.1</b> Single Syringe Dispenser Setup .....	<b>1-3</b>
<b>1.3.2</b> Dual Syringe Diluter Setup .....	<b>1-4</b>
<b>1.3.3</b> Dual Syringe Dispenser Setup .....	<b>1-4</b>
<b>1.3.4</b> Continuous Dispenser Setup .....	<b>1-5</b>
<b>1.4</b> Safety Precautions .....	<b>1-5</b>
<b>1.4.1</b> General Safety Information .....	<b>1-5</b>
<b>1.4.2</b> Operating the Microlab 600 .....	<b>1-6</b>
<b>1.4.3</b> Electrical .....	<b>1-6</b>
<b>1.4.4</b> Radioactive, Biohazardous or Harsh Chemicals .....	<b>1-6</b>
<b>Chapter 2: Hardware Setup</b> .....	<b>2-1</b>
<b>2.1</b> Overview of Microlab 600 Parts List .....	<b>2-2</b>
<b>2.2</b> Selecting the Proper Location .....	<b>2-4</b>
<b>2.3</b> Description of Drive Unit Components .....	<b>2-4</b>
<b>2.3.1</b> Description of the Front View of the Drive Units .....	<b>2-4</b>
<b>2.3.2</b> Description of the Rear View of the Drive Units .....	<b>2-7</b>



2.4 Installation of Drive Unit Parts.....	2-9
2.4.1 Installation of the Valve Assembly .....	2-9
2.4.1.1 Mounting a Valve on the Microlab 600.....	2-9
2.4.1.2 Mounting Two Valves with Cross Tube on the Microlab 600.....	2-10
2.4.2 Installation of Syringe(s) .....	2-11
2.4.2.1 Preparing Syringe(s) for Installation.....	2-13
2.4.2.2 Installing the Syringe(s) .....	2-13
2.4.3 Installation of the Tubing.....	2-15
2.4.3.1 Selecting the Proper Tubing .....	2-15
2.4.3.2 Installing the Tubing.....	2-16
2.4.4 Installation of the Accessory Holder.....	2-19
2.4.5 Tubing Management with the Accessory Holder .....	2-20
2.4.6 Installation of the Hand Probe.....	2-21
2.5 Controller Unit.....	2-22
<b>Chapter 3: Overview of Screens and Buttons .....</b>	<b>3-1</b>
3.1 Splash Screen.....	3-2
3.2 Icon Screens.....	3-2
3.3 Run Screens .....	3-3
3.3.1 Valve Position Indicator Drawings .....	3-4
3.4 Data Entry Screens .....	3-6
3.5 Pop-up Control.....	3-6
3.6 Numeric Keypad .....	3-7
<b>Chapter 4: Basic Controller Setup and Operation.....</b>	<b>4-1</b>
4.1 User Interface Flow Chart.....	4-2
4.2 Hardware Configuration.....	4-2
4.2.1 Syringe Setup .....	4-2
4.2.2 Valve Setup.....	4-3
4.2.3 Triggering.....	4-3
4.3 Software Configuration .....	4-4
4.3.1 Controller.....	4-4



4.3.1.1	Screen Calibration.....	4-4
4.3.1.2	Screen Power Off .....	4-5
4.3.1.3	RAM Used .....	4-5
4.3.1.4	System Trace Logging.....	4-5
4.3.1.5	System Date and Time (Advanced Controller Only) .....	4-5
4.3.1.6	Internal and Removable Storage Used (Advanced Controller Only) ...	4-6
4.3.1.7	MAC Address (Advanced Controller Only).....	4-6
4.3.1.8	Language (Advanced Controller Only) .....	4-6
4.3.2	Versions .....	4-6
4.3.3	600 Series Pump.....	4-6
4.4	Priming the Instrument .....	4-7
4.5	Quick Start .....	4-8
4.5.1	Single Syringe Dispenser.....	4-8
4.5.2	Dual Syringe Diluter .....	4-8
4.5.3	Dual Syringe Dispenser .....	4-9
4.5.4	Continuous Dispenser.....	4-9
4.6	Utilities.....	4-9
4.6.1	Error Log .....	4-10
4.6.2	Update.....	4-10
<b>Chapter 5:</b>	<b>Care and Maintenance .....</b>	<b>5-1</b>
5.1	Yearly Maintenance.....	5-2
5.2	Instrument Calibration .....	5-2
5.3	Deciding When to Clean the Microlab 600.....	5-2
5.4	Cleaning the Fluid Path .....	5-3
5.5	Cleaning the Exterior of the Microlab 600 .....	5-4
5.6	Storing the Microlab 600 .....	5-4
5.7	Replacing Batteries .....	5-4
<b>Chapter 6:</b>	<b>Troubleshooting.....</b>	<b>6-1</b>
6.1	Error Code .....	6-2
6.2	Troubleshooting Guide .....	6-2



<b>6.3</b> Getting Technical Support .....	<b>6-4</b>
<b>6.4</b> Returning Instruments for Repair.....	<b>6-5</b>
<b>Appendices</b> .....	<b>A-1</b>
<b>Appendix A</b> —Technical Specifications.....	<b>A-1</b>
<b>Appendix B</b> —Replacement Parts and Accessories.....	<b>B-1</b>
<b>Appendix C</b> —Hand Probes and Foot Switch.....	<b>C-1</b>
<b>Appendix D</b> —Chemical Compatibility .....	<b>D-1</b>
<b>Appendix E</b> —Instrument Performance Test Reports.....	<b>E-1</b>
<b>Glossary</b> .....	<b>GL-1</b>
<b>Index</b> .....	<b>IN-1</b>

# Welcome

## Welcome to the World of Hamilton Precision Instruments

Congratulations on your purchase of a Hamilton Microlab 600 instrument.

The Hamilton Microlab 600 is a versatile, semi-automatic, precision liquid handler. This family of instruments offers single or dual syringe units that function as dispensers, diluters and continuous dispensers.

The Microlab 600 functions on the principle of liquid/liquid displacement. At the heart of each Microlab 600 is a precise stepper drive motor combined with our uniquely designed Gastight® syringes. The result is a precise and accurate instrument that is very easy to set up and operate.

Proper handling and maintenance of your new Microlab 600 will increase the lifespan of your instrument. To learn about proper care and maintenance of your investment, please take the time to read this manual, including the warranty information.

Hamilton Company would like to thank you for your purchase of the Microlab 600.



WELCOME

# Intended Use

The Microlab 600 family of instruments are bench top devices designed for precision liquid handling. These units are intended for indoor laboratory use by technician grade personnel. These units are also designed for industrial purposes with an emphasis on continuous dispensing in an unattended mode.





# About the Microlab<sup>®</sup> 600 Manuals

## Basic Microlab 600 Manual

This manual contains information on installation of the hardware, care and maintenance, and troubleshooting the Microlab 600. This manual also contains instructions needed to operate the Basic series controller.

## Advanced Microlab 600 Manual

This manual contains information on operating the Advanced controller software. Users of this manual may need to refer back to the Basic Manual for hardware installation, care and maintenance, and troubleshooting the Microlab 600.

## Computer Controlled Microlab 600 Manual

This manual contains information on communicating with the pump through third party software. Users of this manual may need to refer back to the Basic Manual for hardware installation, care and maintenance, and troubleshooting the Microlab 600.

 **Note:** This manual will be on the Software CD as a help file that comes with the appropriate Microlab 600 instrument.

After reading these manuals you should be able to properly operate your Microlab 600.









# Conventions Used in this Manual

Throughout this manual symbols are used to call your attention to various kinds of information.

 **WARNING!** Information that is essential for avoiding personal injury is flagged with the International Warning Symbol.

 **Biohazard:** Information that is relating to interactions with biohazards.

 **Important!** Information that is essential for avoiding damage to equipment.

 **Note:** Interesting information or information that can help improve system performance.





## CHAPTER 1:

# Introduction

This chapter provides a brief overview of the Microlab 600 instruments including the following discussions:

- 1.1 Introduction of the Microlab 600**
- 1.2 Microlab 600 Part Number Nomenclature**
- 1.3 Microlab 600 Hardware Setups**
- 1.4 Safety Precautions**



## 1.1 Introduction of the Microlab 600

The Microlab 600 Series is a family of highly precise syringe pumps designed to simplify common dispensing and diluting tasks in a variety of research environments. Common components of a Microlab 600 pump include a controller, a syringe pump base unit and an application-specific fluid path.

## 1.2 Microlab 600 Part Number Nomenclature

Each Microlab 600 Series part number describes the type of controller, type of syringe pump base unit and type of application specific fluid path. Below is a discussion of how a Microlab 600 part number is created.

Microlab 600 Series Part Number: ML6**X**<sup>1</sup>**X**<sup>2</sup>-**XXX**<sup>3</sup>

- X**<sup>1</sup> This digit defines the controller type. There are three standard controller types.
- 1 This system includes a Basic controller.
  - 2 This system includes a Basic controller plus the Advanced upgrade kit. The upgrade kit comes with a proprietary SD card that adds memory to the controller and unlocks the Wizard and Custom Method functionality.
  - 3 This system does not include a controller. This system must be connected to a PC running custom developed software. A CD containing the Application Programming Interface (API) is provided along with a programming manual and example programs in LabVIEW™, Visual Basic® and Visual C#®.
- X**<sup>2</sup> This digit defines the syringe pump base unit. There are two pump types. Each pump comes with the appropriate valves pre-installed.
- 0 This system includes a single syringe base unit with a standard input and output valve.
  - 5 This system includes a dual syringe base unit with a Universal Valve installed.
- XXX**<sup>3</sup> These letters define the tubing and hand probes that are shipped with the system to accomplish a defined application. For detailed information on the products included for each application please see Chapter 2.1.

**Table 1-1 Microlab 600 Application Packages**

XXX <sup>3</sup>	Application
DIS	Single or Dual Syringe Dispenser package
DIL	Dual Syringe Diluter package
DTHP <sup>1</sup>	Disposable Tip Hand Probe Diluter package <sup>2</sup>
CNT	Continuous Dispensing package
New Application Packages	New packages will be created on occasion. Details about these packages can be found at <a href="http://www.hamiltoncompany.com/microlab600">www.hamiltoncompany.com/microlab600</a>

1—Only available with the Advanced Controller  
2—This package will come with the Disposable Tip Hand Probe and the Cable Management System.

## 1.3 Microlab 600 Hardware Setups

There are four major hardware setups possible with the Microlab 600. Below is a brief description of each setup describing the intended use for each configuration.

**Note:** The Microlab 600 is compatible with syringes from 10  $\mu\text{L}$  to 50 mL. To achieve the highest level of accuracy, the proper syringe should be selected for the range of dispense volumes to be performed (See Section 2.4.2). For example, the proper syringe size to use for dispensing 250  $\mu\text{L}$ , 500  $\mu\text{L}$ , 750  $\mu\text{L}$  and 1 mL from a single instrument setup would be a 1 mL syringe. This is the smallest syringe that can be programmed to accomplish all four desired dispense volumes. When selecting a syringe the volumes to be dispensed should fall between 10% and 100% of the nominal syringe volume for a 1 mL syringe that would be between 100  $\mu\text{L}$  and 1 mL. Smaller volumes are possible with a slight loss in accuracy and precision (See Section 2.4.2).

### 1.3.1 Single Syringe Dispenser Setup

The Single Syringe Dispenser setup is designed to dispense precise volumes of liquid from a reservoir out through a hand probe. There is a single valve that connects the syringe to tubing. When the valve rotates it connects the syringe to the input or the output tubing. The input tubing connects the syringe to a reservoir of liquid. The output tubing connects the syringe to a hand probe. At the press of a button, the valve will position to the input so the syringe can fill with a user defined volume of liquid from the reservoir. A second push of a button will dispense the user defined volume from the tip of the hand probe.



A brief animation of “How a Microlab 600 Dispenser Works” can be found at [www.hamiltoncompany.com/microlab600](http://www.hamiltoncompany.com/microlab600).

### 1.3.2 Dual Syringe Diluter Setup

The Dual Syringe Diluter setup is ideally designed to perform dilutions. The two syringes operate as one to accurately draw the sample (right syringe) and diluent (left syringe) into the system before dispensing the two liquids into a final container where they mix to complete the dilution. This application could be accomplished with a single syringe system but the dilution range would be limited to the volume range of a single syringe. With two syringes it is possible to use a 50 mL syringe for diluent and a 10  $\mu$ L syringe to draw up the sample. With this setup it is possible to perform a 50,000 fold dilution in a single step. When compared to Class A glassware this is an incredible savings of buffer and time.

The basic dilution method involves priming the entire system with diluent. Next, the right syringe draws sample into the hand probe. The sample is completely contained in the dispense tubing and never comes into contact with the right syringe. At the same time the sample is drawn, the left syringe fills with diluent from the reservoir. Next, the two syringes dispense their entire volume out through the hand probe. The sample is dispensed from the tubing first followed by the diluent which washes out the tubing and prepares the system for the next dilution.

A brief animation of “How a Microlab 600 Diluter Works” can be found at [www.hamiltoncompany.com/microlab600](http://www.hamiltoncompany.com/microlab600).

### 1.3.3 Dual Syringe Dispenser Setup

The Dual Syringe Dispenser setup has the same capabilities as two Single Syringe Dispensers that receive commands from a single controller. Instead of one valve and one syringe like the Single Syringe Dispenser, there are two pairs of syringes and valves. Each pair works independently of the other, meaning that each can be setup with a different volume syringe and can be programmed to dispense a different volume of liquid. The fluid paths are maintained completely separate so liquid in the left syringe will not mix with liquid in the right syringe until the two liquids are dispensed out the end of the hand probe. This setup is ideal for applications like epoxy dispensing where no mixing should occur until the proper quantities of each liquid have been dispensed.

A brief animation of “How a Microlab 600 Dispenser Works” can be found at [www.hamiltoncompany.com/microlab600](http://www.hamiltoncompany.com/microlab600).

### 1.3.4 Continuous Dispenser Setup

The Continuous Dispenser setup is designed to eliminate the time wasted waiting for the syringe to refill between dispenses. This dual syringe system automatically fills one syringe while the other syringe is dispensing. Since there is always one full syringe, the wait time is eliminated. This setup effectively cuts the work time of the Single Syringe Dispenser setup in half without sacrificing accuracy and precision by increasing the syringe speed. This setup requires that both the left and the right syringes are the same volume.

A brief animation of “How a Microlab 600 Dispenser Works” can be found at [www.hamiltoncompany.com/microlab600](http://www.hamiltoncompany.com/microlab600).

## 1.4 Safety Precautions

For proper handling and care of the Microlab 600 it is essential that operating and service personnel follow general safety procedures and safety instructions described in this manual. Service maintenance must only be performed by an authorized service technician.

### 1.4.1 General Safety Information

The Microlab 600 should be placed in a location where personnel have easy access to the front, back and sides for ease of operation and maintenance. Before operating the instrument, determine the amount of space you will need for your Microlab 600.

Cleaning, dismantling and/or performing maintenance on the Microlab 600 should only be performed by properly trained personnel who are aware of possible dangers. Only certified repair technicians are authorized to perform mechanical maintenance on the Microlab 600.

When transporting the Microlab 600 for repair or shipment it should be properly packaged inside the original shipping container. All Microlab 600 instruments that are sent back to Hamilton Company for repair must be decontaminated before they are shipped.

Only the original approved parts and accessories may be used with the Microlab 600. Any alterations or modifications to the instrument may be dangerous and will void the warranty.



## 1.4.2 Operating the Microlab 600

When using the Microlab 600, Good Laboratory Practices (GLP) should be observed. Users should wear protective clothing, safety glasses and protective gloves, especially if working with radioactive, biohazardous or harsh chemicals.

During the operation of a Microlab 600, stand clear of moving parts. Never try to remove valves, syringes or tubing when the Microlab 600 syringe drive mechanism is moving. Never move the Microlab 600 while it is in operation.

If an accidental spill occurs, turn the instrument Off and wipe it down with the appropriate disinfectant or chemical. Remember to take into account the nature of the spill and the necessary safety precautions.

## 1.4.3 Electrical

The Microlab 600 must be turned Off and disconnected from the power source when removing any mechanical or electrical components.

Do not connect the unit to a power source of any other voltage (See Appendix B for appropriate power cords) or frequency beyond the range stated on the power rating. Check to make sure the appropriate power cord for your country was received.

Avoid damaging the power cord while operating the instrument. Do not bend excessively, step on or place heavy objects on the power cord. A damaged power cord may easily become a shock or fire hazard. Never use a damaged power cord.

Only connect the Microlab 600 to a grounded outlet.

## 1.4.4 Radioactive, Biohazardous or Harsh Chemicals



**Biohazard:** The Microlab 600 does not provide any user protection against radioactivity, biohazardous or harsh chemicals.

When operating the Microlab 600 wear the appropriate laboratory clothing. Operators must be trained to handle hazardous materials before working with them in conjunction with the Microlab 600 pump. If the Microlab 600 becomes contaminated with radioactive, biohazardous or harsh chemicals, it should be cleaned immediately, see Chapter 5 for maintenance procedures. Failure to observe and carry out the procedures may impair or damage the Microlab 600. Materials consumed or produced during use of this device should be disposed of in accordance with local, state and federal laws.



## CHAPTER 2:

# Hardware Setup

This chapter provides detailed information on the features and installation of the Microlab 600 hardware. Information in this chapter includes:

- 2.1 Overview of Microlab 600 Parts List**
- 2.2 Selecting the Proper Location**
- 2.3 Description of Drive Unit Components**
- 2.4 Installation of Drive Unit Parts**
- 2.5 Controller Unit**



## 2.1 Overview of Microlab 600 Parts List

The Microlab 600 instruments come complete with everything needed to get started. For replacement parts, please refer to Appendix B Replacement Parts and Accessories. Optional hand probes are also available and can be found in Appendix C.

Unpack the Microlab 600 and verify that all parts have been received. The parts list for each family of instruments is displayed in the tables below.

**Table 2-1 Microlab 600 System Descriptions**

Instrument Part Number	Drive Unit Part Number	Controller Part Number	Controller Upgrade Kit Part Number (See Table 2-2 for details)	Probe and Tubing Kit Description (See Table 2-3 for details)
ML610-DIS	<b>Single Syringe</b> 61501-01	61500-05	N/A	Single Dispense Kit
ML615-DIL	<b>Dual Syringe</b> 61502-01	61500-05	N/A	Diluter Kit
ML615-DIS	<b>Dual Syringe</b> 61502-01	61500-05	N/A	Dual Dispense Kit
ML615-CNT	<b>Dual Syringe</b> 61502-01	61500-05	N/A	Continuous Dispense Kit
ML620-DIS	<b>Single Syringe</b> 61501-01	61500-05	61500-02	Single Dispense Kit
ML625-DIL	<b>Dual Syringe</b> 61502-01	61500-05	61500-02	Diluter Kit
ML625-DTHP	<b>Dual Syringe</b> 61502-01	61500-05	61500-02	DTHP Diluter Kit
ML625-DIS	<b>Dual Syringe</b> 61502-01	61500-05	61500-02	Dual Dispense Kit
ML625-CNT	<b>Dual Syringe</b> 61502-01	61500-05	61500-02	Continuous Dispense Kit
ML630	<b>Single Syringe</b> 61501-01	N/A	61500-03	N/A
ML635	<b>Dual Syringe</b> 61502-01	N/A	61500-03	N/A

 **Note:** Each unit will come with the Basic Manual (p/n 61440-01), the power supply (p/n 61092-01) and user selected power cord (see Appendix B). The system will also ship with one syringe per syringe drive which can be user selected at the time the instrument is purchased.

Table 2-2 Upgrade Kits

Upgrade Kit Part Number	Software CD Part Number	SD Card Part Number	USB Adapter Part Number	Advanced Controller Manual Part Number	Ethernet Cable
61500-02	61495-01	61257-01	61497-01	61441-01	N/A
61500-03	61495-01	N/A	N/A	N/A	54308-01

Table 2-3 Probe and Tubing Kits

Probe and Tubing Kit Description	Hand Probe Part Number	Fill Tubing 12 gauge 61614-01 18 gauge 61615-01	Dispense Tubing 12 gauge 240133 18 gauge 240134	Continuous Fill Tubing 12 gauge 61491-01 18 gauge 61491-02
Single Dispense Kit	<b>Concorde CT Probe</b> 61401-01	User Defined 12 or 18 gauge 1 piece	User Defined 12 or 18 gauge 1 piece	N/A
Diluter Kit	<b>Concorde CT Probe</b> 61401-01	User Defined 12 or 18 gauge 1 piece	User Defined 12 or 18 gauge 1 piece	N/A
DTHP Diluter Kit <sup>1</sup>	<b>Disposable Tip Probe</b> 63960-02	N/A	12 gauge 1 piece	N/A
Dual Dispense Kit	<b>Dual Push Button Probe</b> 62541-01	User Defined 12 or 18 gauge 2 pieces	User Defined 12 or 18 gauge 2 pieces	N/A
Continuous Dispense Kit	<b>Concorde CT Probe</b> 61401-01	N/A	User Defined 12 or 18 gauge 1 piece	User Defined 12 or 18 gauge 1 piece

If components are missing please contact Hamilton Customer Service at (888) 525-2123.  
1—This unit will also come with the Cable Management System.

 **Note:** The shipping container should be saved in case the Microlab 600 needs to be returned to Hamilton Company for service.



## 2.2 Selecting the Proper Location

When selecting a location for your Microlab 600, choose an area that is clean, dry, level and away from hazardous chemicals, radiation and/or hazardous biological substances. Leave enough space around the unit for ventilation. Make sure there is a power source nearby to connect the power cord.

## 2.3 Description of Drive Unit Components

The drive unit is the heart of the Microlab 600. The drive unit contains a precision drive motor, the syringe drive mechanism, the valve assembly, syringe selection button, prime button, power button and hand probe receptacles.

This section will show a detailed diagram of the front and back of the Microlab 600 single and dual syringe drive units and provide a description of the buttons and port receptacles required to operate the Microlab 600.

### 2.3.1 Description of the Front View of the Drive Units

**Figure 2-1 Front View of the Single Syringe Drive Unit**

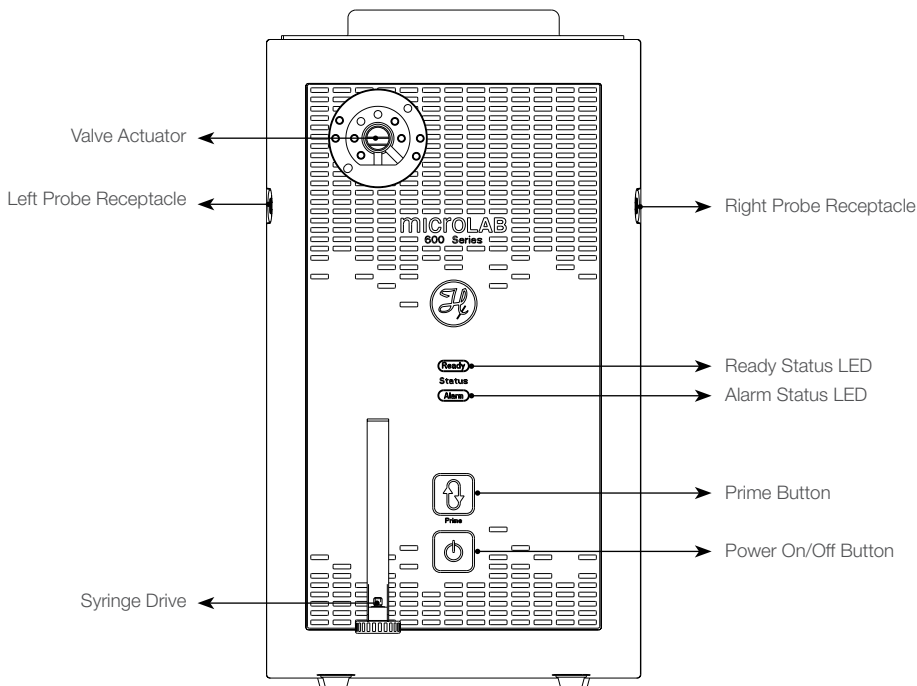
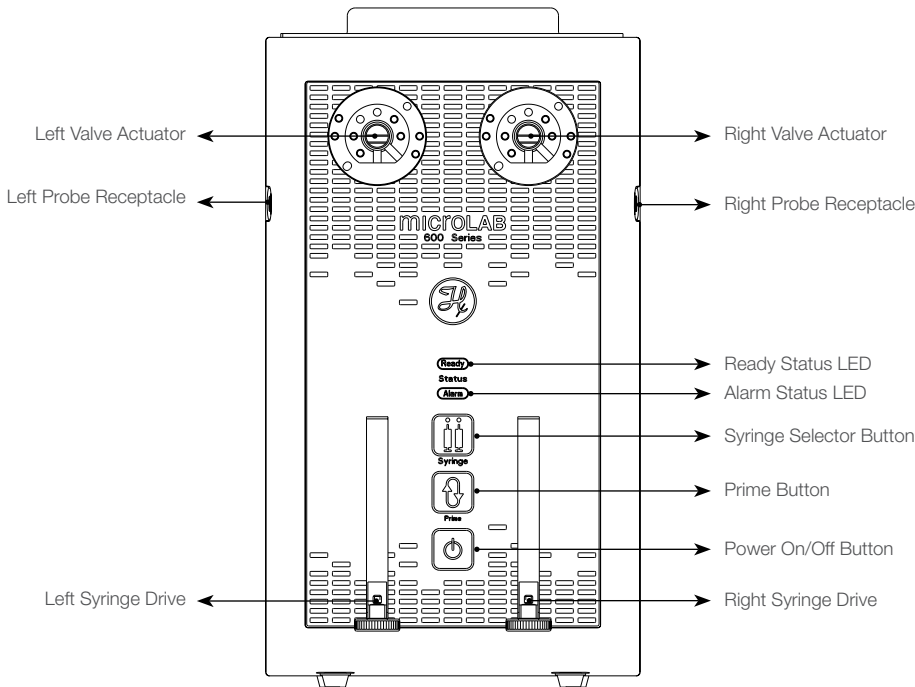

Figure 2-2 Front View of the Dual Syringe Drive Unit



### Valve Actuator

The valve actuator turns the valve at the appropriate time to fill and dispense solutions. A variety of valves can be mounted to the valve actuator. See Section 2.4.1 for valve installation instructions.

### Probe Receptacle

There are two probe receptacles for this unit and they are located on the upper left and upper right side of the instrument. You may insert a hand probe or foot switch to either probe receptacle. When a signal is received by the pump through the probe receptacle it is triggered to perform the next action in the current method.

### Syringe Drive

The syringe drive mechanism positions Hamilton precision syringes with high-resolution stepper motors. The syringes are threaded into the valve and the plunger is attached to the syringe drive with a thumbscrew. See Section 2.4.2 for installing the syringes.



**Ready****Ready LED**

The Ready LED is used to indicate the status of the pump. Below are the different types of indication:

- ▶ **Rapid Blinking**—This indicates the pump is in DHCP mode. It is requesting an IP address from the network server.
- ▶ **Slow Blinking**—Blinking about once per second indicates the pump is ready but not initialized. When a controller is connected to the pump, the ready indicator will blink until the controller is connected. If another device is connected, the ready indicator will continue to flash until the pump has initialized.
- ▶ **Solid Green**—This indicates the pump is initialized and ready. Once the controller connects to the pump, the LED will be solid green. If connected to another device once the instrument is initialized, then the Ready LED will be solid green.

**Alarm****Alarm LED**

If a problem arises, for example a syringe stall, the red LED light will be turned on behind the Alarm symbol to let the user know that there is a problem. See Section 6.2 for troubleshooting guidelines.

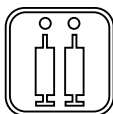
**Syringe Selector Button**

This button is only found on dual syringe systems and allows the user to select which side of the pump to prime. There is a setting for the left side only, right side only or both. The setting is indicated by a blue LED light above each syringe. When a syringe is selected, the blue LED will turn on. When the instrument is first turned on, both syringes will be selected by default.

**Prime Button**

This button is used to lower the syringe drive allowing replacement of the syringes or to prime the instrument prior to use. To lower the syringe drives, press and hold the Prime button. After three seconds the drive will begin to lower. Continue to press the button until the drives are halfway down. To prime the instrument, see Section 4.4 for details.

**Power On/Off Button**

The Power On/Off button is located on the front center of the drive unit. When the Microlab 600 is turned on a blue LED light will illuminate the Power button.

**Note:** To reset the pump back to factory settings the pump must be turned Off. Press and hold the Prime button and power the instrument On; continue to hold the Prime button for three seconds. The power LED light will flash five times to indicate that you have correctly reset the pump to factory default settings.

## 2.3.2 Description of the Rear View of the Drive Units

Figure 2-3 Rear View of the Microlab 600

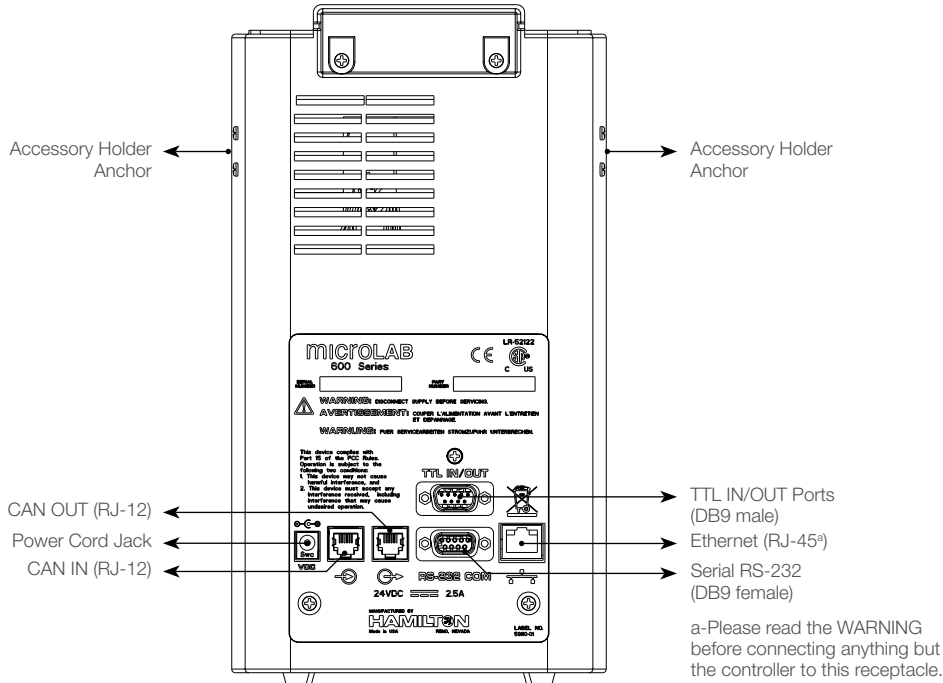

### Ethernet (RJ-45)

The Ethernet receptacle is located on the back of the drive unit. This port is used to connect to the controller or a network.

**⚠ WARNING!** The Microlab 600 controller is powered using Power Over Ethernet (POE) supplied for the Microlab 600 pump. When connecting the Microlab 600 pump to a computer, the POE MUST be turned Off to avoid damage to the computer. To turn the POE Off or On the Microlab 600 must first be turned Off. Next toggle the POE setting by pressing and holding the Power button for three seconds during power up. The green Ready light will flicker when POE has been turned On or will illuminate solid when POE is turned Off. The POE state will be stored in memory so the setting will remain when the instrument is turned Off and back On.

### Accessory Holder Anchor

The Accessory Holder Anchors are located on the upper left and right sides of the instrument. This is the location where the Accessory Holder is to be installed. For detailed installation instructions, please see Section 2.4.4.

### Power Cord Jack

The Power Cord jack is located on the back of the drive unit and accepts the output of a 24 VDC power supply. The universal power supply accepts power from 110–240V and connects to a power outlet using a standard computer power cable.

### CAN IN and OUT (RJ-12)

The CAN IN and OUT receptacles are located on the back of the drive unit. These two ports are used for daisy chaining instruments together. Daisy chaining functionality is not supported by the basic controller.

### TTL IN/OUT (DB9 male)

The TTL IN/OUT is located on the back of the drive unit. This port is designed to allow the user to wire other devices to the Microlab 600. TTL communication is not supported by the basic controller.

**Table 2-4 TTL Pin Configuration**

Pin	Function
1	Output 1 (O <sup>0</sup> )
2	Output 2 (O <sup>1</sup> )
3	Output 3 (O <sup>2</sup> )
4	Output 4 (O <sup>3</sup> )
5	Input 1 (I <sup>0</sup> )
6	Input 2 (I <sup>1</sup> )
7	Input 3 (I <sup>2</sup> )
8	Input 4 (I <sup>3</sup> )
9	Ground

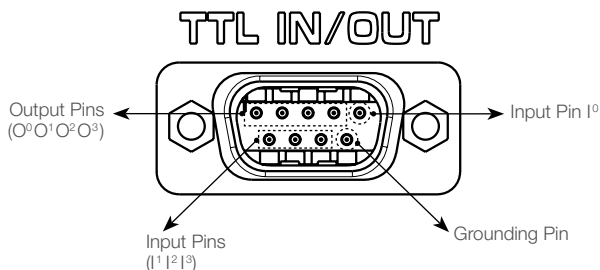

### Serial RS-232 (DB9 female)

The RS-232 COM port is located on the back of the drive unit. This port is used to connect and control the Microlab 600. A manual describing the RS-232 protocol can be downloaded at [www.hamiltoncompany.com/microlab600](http://www.hamiltoncompany.com/microlab600).



## 2.4 Installation of Drive Unit Parts

In this section the user will learn how to properly install the valve assembly, syringes, tubing, Accessory Holder and the hand probe.

- ▶ 2.4.1 Installation of the Valve Assembly
- ▶ 2.4.2 Installation of Syringes
- ▶ 2.4.3 Installation of the Tubing
- ▶ 2.4.4 Installation of the Accessory Holder
- ▶ 2.4.5 Tubing Management with the Accessory Holder
- ▶ 2.4.6 Installation of the Hand Probe

### 2.4.1 Installation of the Valve Assembly

The Microlab 600 uses a universal valve that can support single dispensing, dual dispensing, diluting and continuous dispensing. Each configuration requires unique plumbing, as described in Section 2.4.3.

#### 2.4.1.1 Mounting a Valve on the Microlab 600

**Figure 2-4 Microlab 600 Valve Parts**

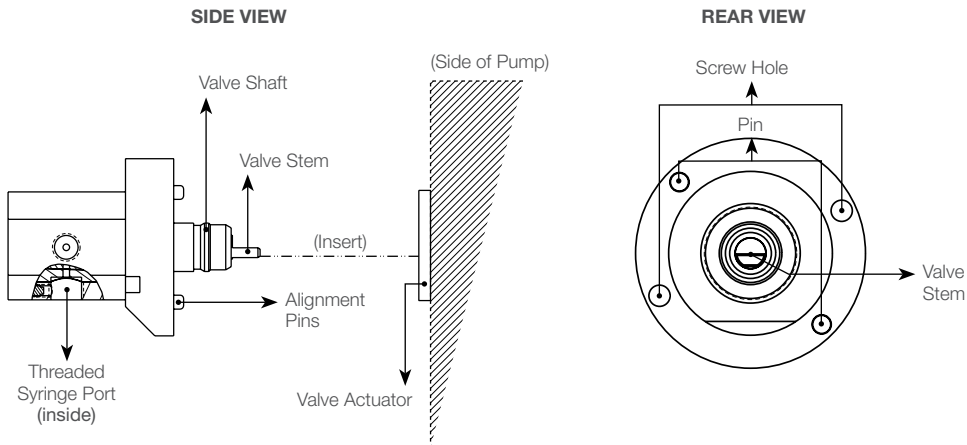

**Note:** The valve assembly will be installed on the Microlab 600 before it leaves Hamilton Company. For single syringe dispensers, the plug configuration will be as depicted in Figure 2-7. For dual syringe units, the valve assembly will be set as a diluter configuration.

- Step 1.** Insert the valve shaft into the valve actuator and rotate the valve until the valve stem engages with the valve drive. See Figure 2-5A.
- Step 2.** With the valve stem and valve drive engaged, rotate the valve until the alignment pins slip into the front of the instrument. The threaded syringe port should point down toward the syringe drive mechanism. See Figure 2-5B.
- Step 3.** Install the valve screws to complete the valve mounting.

The final assembly of the valve is depicted in Figure 2-5C.

**Figure 2-5 Valve Assembly Diagram**

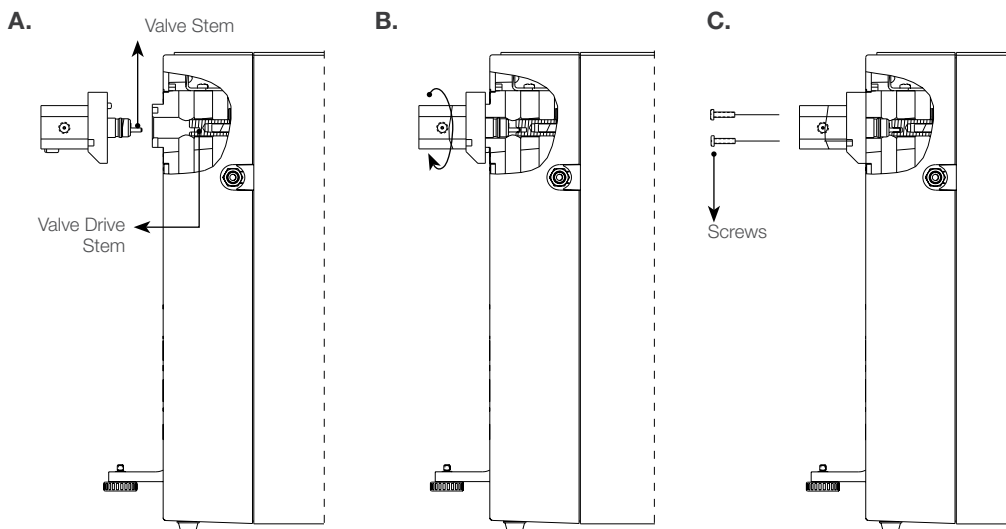

#### 2.4.1.2 Mounting Two Valves with Cross Tube on the Microlab 600

- Step 1.** Take the left valve and engage the valve stem with the valve actuator and then rotate to engage the alignment pins as described in Steps 1 and 2 of Section 2.4.1.1.
- Step 2.** Repeat step 1 with the right valve.
- Step 3.** Remove both valves from the instrument.
- Step 4.** Screw the cross tube into the port on the left valve that is marked with an "L". Do not completely tighten.

- Step 5.** Screw the cross tube into the valve port on the right valve marked by an “R”. The valve shafts for the left and right valve should both point in the same direction so they can be slipped into the valve actuator. Do not completely tighten the tubing.
- Step 6.** Place the valve assembly onto the instrument as one assembled unit.
- Step 7.** Install two screws into each valve to secure the assembly to the instrument.
- Step 8.** Completely tighten the cross tube on both valves.

## 2.4.2 Installation of Syringe(s)

In this section the user will learn how to properly prepare and install the syringes onto the Microlab 600. Before the syringes are installed on the Microlab 600, you must first decide which syringes to use. Use Table 2-5 to select the best syringe for your application.

**Table 2-5 Bubble Free Prime Syringe Sizes**

Syringe Volume (µL)	Part Number	Optimal Range (µL)	Flow Rate (µL/sec)		
			Recommended	Minimum	Maximum
10	59000-05	1.0–10	5	0.003	6.5
25	59000-10	2.5–25	12.5	0.007	16.5
50	59000-15	5–50	25	0.014	33
100	59000-20	10–100	50	0.03	66.5
250	59000-25	25–250	125	0.07	166.5
500	59000-30	50–500	250	0.14	333
1,000	59000-35	100–1,000	500	0.3	665
2,500	59000-40	250–2,500	625	0.7	1,250
5,000	59000-45	500–5,000	1250	1.4	2,500
10,000	59000-50	1,000–10,000	2500	3	5,000
25,000	59000-55	2,500–25,000	3125	7	6,000 <sup>1</sup>
50,000	59000-60	5,000–50,000	3125	14	6,000 <sup>1</sup>

<sup>1</sup>—For these syringes it may be required to cut the tip of the dispense tube off to avoid stalling the instrument.



The Bubble Free Prime syringes are specifically designed for the Microlab 600. They are Gastight syringes with a unique plunger tip. The plunger tip extends through the top of the syringe and slightly into the valve. These syringes are designed to reduce dead volume, improve priming and limit sample carryover.

 **Note:** When using the Continuous Dispenser setup with the basic controller, the left and right syringe must be the same size. With the upgraded controller, it is possible to create a custom method using syringes of differing sizes.

**Table 2-6 Syringe Accuracy and Precision**

Syringe Size (μL)	Percent Stroke	Accuracy (±)	Precision
10	5% ≤ Stroke < 30%	3.0%	2.0%
	30% ≤ Stroke	2.0%	0.2%
	Stroke = 100%	1.0%	0.2%
25	5% ≤ Stroke < 30%	3.0%	2.0%
	Stroke = 30%	1.5%	0.2%
	Stroke = 100%	1.0%	0.2%
50	5% ≤ Stroke < 30%	2.0%	1.0%
	Stroke = 30%	1.0%	0.2%
	Stroke = 100%	1.0%	0.2%
100	5% ≤ Stroke < 30%	3.0%	1.5%
	Stroke = 30%	1.2%	0.5%
	Stroke = 100%	1.0%	0.2%
250	5% ≤ Stroke < 30%	3.0%	1.5%
	Stroke = 30%	1.2%	0.5%
	Stroke = 100%	1.0%	0.2%
500	1% ≤ Stroke < 5%	3.0%	1.5%
	5% ≤ Stroke < 30%	1.2%	0.5%
	Stroke = 30%	1.0%	0.2%
	Stroke = 100%	1.0%	0.2%
1,000 and larger	1% ≤ Stroke < 5%	3.0%	1.5%
	5% ≤ Stroke < 30%	1.2%	0.5%
	Stroke = 30%	1.0%	0.2%
	Stroke = 100%	1.0%	0.2%

### 2.4.2.1 Preparing Syringe(s) for Installation

Before inserting the plunger into the syringe barrel the plunger tip will need to be conditioned. To condition the plunger tip, first wet the tip and insert into the glass barrel, stroke the syringe 10 times while applying steady and even pressure; avoid twisting movements.

☆ **Important!** To condition the tip and barrel, wet the plunger tip with deionized water or a solvent. Do NOT use viscous oils to lubricate plunger tips.

### 2.4.2.2 Installing the Syringe(s)

- Step 1.** Condition the syringes as described in Section 2.4.2.1.
- Step 2.** Power On the Microlab 600 using the Power On/Off button.
- Step 3.** Press and hold the Prime button for three seconds. After three seconds the syringe drives will initialize and then both drives will move downward. Continue to hold the Prime button until the syringe drive has moved down approximately halfway. Release the Prime button and the syringes will stop.
- Step 4.** Insert the syringe into the valve and turn the glass barrel clockwise until it is fingertight.

 **Note:** For 10, 25, 50 and 100  $\mu\text{L}$  syringes a small PTFE washer is provided. This washer should be placed on the top of the syringe to seal between the valve and the syringe termination. When the plunger is at the zero line a small piece of the plunger tip will stick out the top of the syringe to align the washer while the syringe is tightened into the valve.

- Step 5.** Pull the plunger down to the drive stem and fasten the thumbscrew to the plunger. Holding the plunger and thumbscrew; gently screw the thumbscrew into the threaded plunger end. Make sure this is fingertight. The syringe should now be properly attached to the Microlab 600.
- Step 6.** (Optional) Each pump comes with an Allen wrench in the accessory box. This Allen wrench may be used to secure the set screw on the valve(s) to hold the syringe(s) in place. Make sure not to overtighten. Overtightening the set screws may cause the syringe(s) to crack. Reference Figure 2-6 for details.

 **Note:** For the Universal Valve, attach the syringe plunger to the outer most hole on the syringe drive.



Figure 2-6 Installing the Syringe

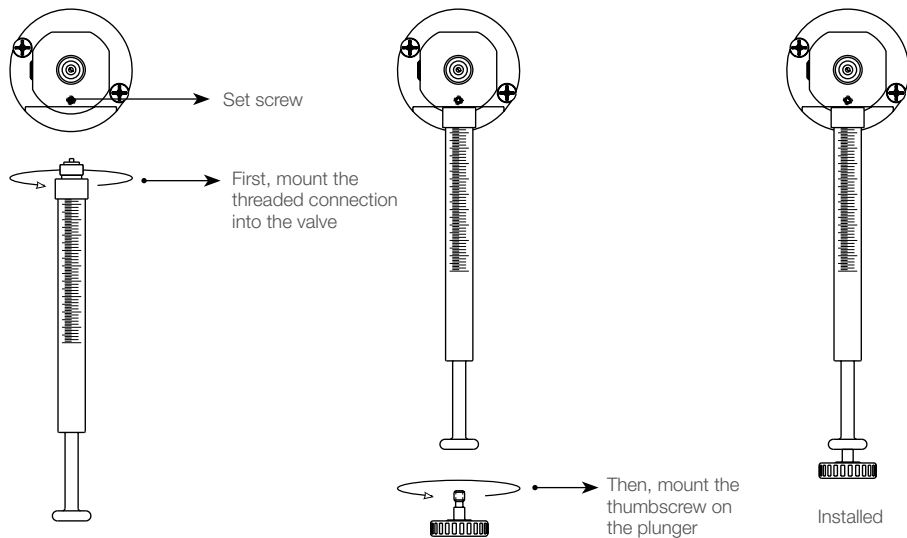

☆ **Important!** Always tighten syringes so that they are fingertight. Syringes that are over- or under-tightened can cause problems with your Microlab 600.

- ▶ Syringes that are over-tightened may cause leaks or damage to the valve.
- ▶ Syringes that are under-tightened may cause leaks.

⚠ **WARNING!** Use extreme caution when removing cracked or broken syringes. Always wear protective gloves and eye wear.

📄 **Note:** When installing syringes for a dilution application the diluent syringe should be placed on the left side of the instrument, while the sample syringe should be placed on the right side of the instrument.

### 2.4.3 Installation of the Tubing

The Microlab 600 instrument uses 12 and 18 gauge tubing for dispensing applications. The tubing comes in two different types, fill and dispense. The fill tubing has a blunt end and is designed to go into a reservoir of liquid. The dispense tubing has a tapered tip and is designed to minimize droplet formation.

#### 2.4.3.1 Selecting the Proper Tubing

When selecting the proper tubing the user needs to consider the syringe volume and viscosity of the solutions that are to be used in the Microlab 600. Table 2-7 is a reference guide to help in selecting the appropriate tubing size. See Appendix B for information on ordering extra tubing.

 **Note:** When the Microlab 600 was purchased the proper tubing was chosen by Hamilton based on the syringe(s) that were ordered. If alternate tubing is desired, it must be purchased separately.

**Table 2-7 Tubing Selection Guide**

Syringe Size	Tubing Gauge for Standard Aqueous Solutions	Tubing Gauge for Viscous and Foaming Liquids
10 µL	18	18
25 µL	18	18
50 µL	18	18
100 µL	18	18
250 µL	18	18
500 µL	18	18
1.0 mL	18	18
2.5 mL	18	12
5.0 mL	12	12
10 mL	12	12
25 mL	12 <sup>1</sup>	12 <sup>1</sup>
50 mL	12 <sup>1</sup>	12 <sup>1</sup>

1—When using speeds faster than the default, or with viscous solutions, it may be necessary to cut the tip of the dispense tube off to avoid stalling the instrument.



 **Note:** If you are using the diluter setup you will need to select tubing based on the volume of the largest syringe used in the application.

☆ **Important!** The volume of the sample aspirated should not exceed 80% of the internal volume of the tubing. This will avoid contamination of the right syringe with the sample. Tubing volumes and custom length tubing are listed in Appendix B.

### 2.4.3.2 Installing the Tubing

- Step 1.** Before installing the tubing, wet the tubing fittings.
- Step 2.** Make sure the tubing is free of crimps or blockages. Crimping or blocking within the tubing may cause leaks or air bubbles. If the tubing is damaged, do not use it and replace with new tubing.
- Step 3.** Determine which type of valve configuration is to be used. See Figures 2-7 through 2-10 for details.
- Step 4.** Insert the wetted tubing fitting into the appropriate threaded valve port and tighten the fitting fingertight.

☆ **Important!** Never over tighten the tubing. Over tightening may result in damage to the valve and/or the tubing.

Use the following figures as a guide for final assembly of the valves with the appropriate tubing and plug configuration:

- ▶ **Figure 2-7** Single Syringe Dispenser Valve and Tubing Assembly
- ▶ **Figure 2-8** Dual Syringe Diluter Valve and Tubing Assembly
- ▶ **Figure 2-9** Dual Syringe Dispenser Valve and Tubing Assembly
- ▶ **Figure 2-10** Dual Syringe Continuous Dispenser Valve and Tubing Assembly



**Figure 2-7 Single Syringe Dispenser Valve and Tubing Assembly****Figure 2-8 Dual Syringe Diluter Valve and Tubing Assembly**

Figure 2-9 Dual Syringe Dispenser Valve and Tubing Assembly



In a dispensing application there are two configurations possible. Use the top configuration if you plan to switch between diluting and dispensing applications. Use the bottom configuration if you are only dispensing and are concerned about sample carryover.

**Figure 2-10 Dual Syringe Continuous Dispenser Valve and Tubing Assembly**

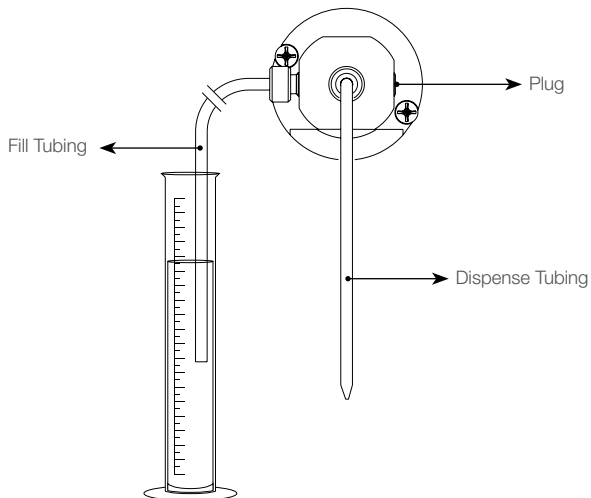
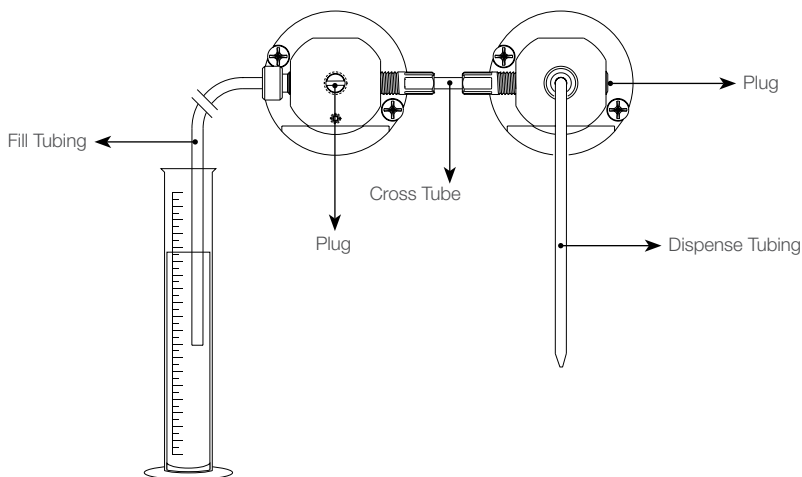
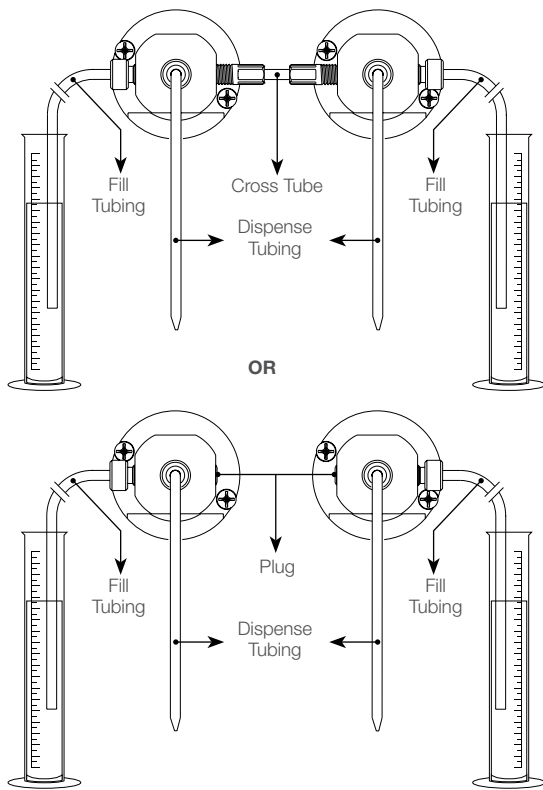
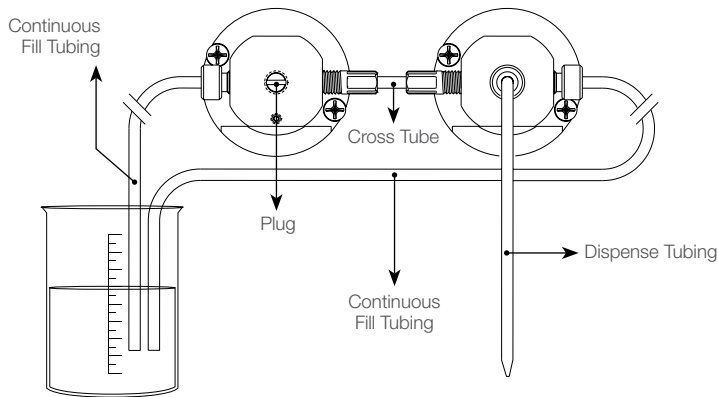

**Note:** All dual syringe pumps will come from the factory set in the diluter configuration. If this is not the desired application, refer to the appropriate configuration and change the pump accordingly.

### 2.4.4 Installation of the Accessory Holder

The Accessory Holder is capable of holding the Concorde CT and Dual Push Button hand probes. It also has a Tubing Management System to eliminate unnecessary cord clutter on the bench top or workstation.

The Accessory Holder may attach to the left or right accessory holder anchor of the instrument.

- Step 1.** Select the side of the instrument where you would like the Accessory Holder to be attached and remove the plastic screw plugs.
- Step 2.** Place a washer and then a spacer onto each of the installation screws.
- Step 3.** Insert each screw assembly into the screw holes on the side of the instrument and tighten with a screwdriver.

**☆ Important!** Never over tighten the tubing. Over tightening may result in damage to the valve and/or the tubing.

- Step 4.** Attach the accessory holder panel onto the screw assembly. There are cutouts on the back of the accessory holder panel. Place the rounded portion of the cutout on the screws and push the assembly down for final assembly. See Figure 2-11 for details.

**Figure 2-11** Installation of the Accessory Holder

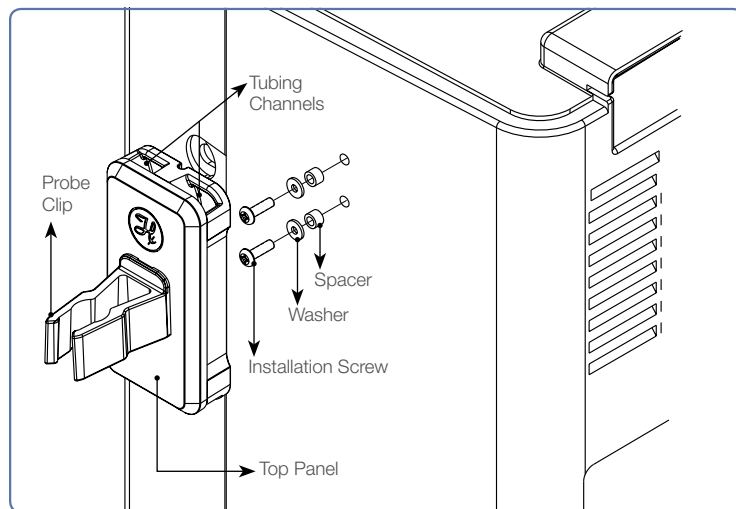

### 2.4.5 Tubing Management with the Accessory Holder

- Step 1.** Attach the Accessory Holder and the hand probe as described in the previous section.
- Step 2.** Choose which tubing channel will fit your tubing and trigger wire the best. The larger channel is for Dual Syringe Dispenser applications where there will be two tubes and a trigger wire. The smaller channel is for most other instrument setups.
- Step 3.** Use your thumb to press on the probe clip. Pressing towards the front or back of the instrument will hinge the top plate covering the channel and will provide access to the channel.
- Step 4.** Insert the tubing and trigger wire into the channel and release the probe clip. The top plate is spring loaded and should cover the channel and hold the tubing in place.

 **Note:** There is a wire stand that can be mounted to the Accessory Holder to keep the tubing completely off the workstation. See Figure 2-12.

**Figure 2-12 Final Assembly of the Tubing Management System**

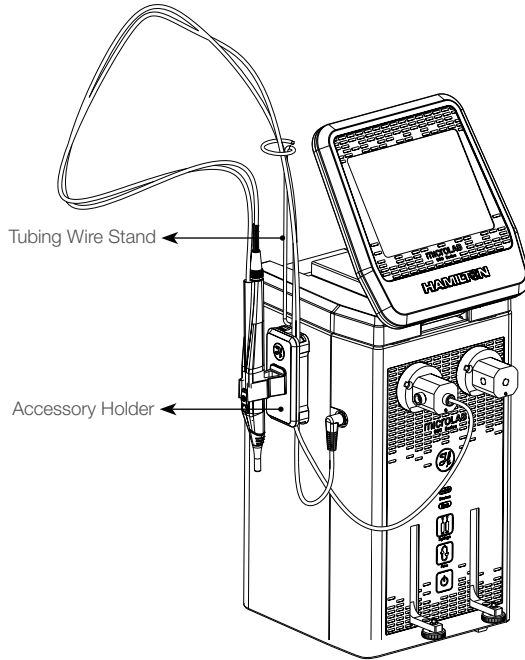

### 2.4.6 Installation of the Hand Probe

Hand probe receptacles are located on the left and right side of the drive unit; see Figure 2-2 for details. The trigger wire for the hand probe or foot switch may be inserted into either of these receptacles. The dispense tubing (12 or 18 gauge) may be threaded through the hand probe. See Appendix C for optional hand probes and foot switch.

**Note:** When installing the probe on the Microlab 600, thread the tubing from the hand probe through the clips that hold the trigger wire and the dispense tubing together.

## 2.5 Controller Unit

The controller unit is the final piece that is connected to the drive unit. It will connect from the Ethernet port on the controller via the controller cord into the Ethernet port on the pump (see Figure 2-3). The controller unit will send instructions to the drive unit via a touchscreen interface.

**Figure 2-13 Controller Unit**

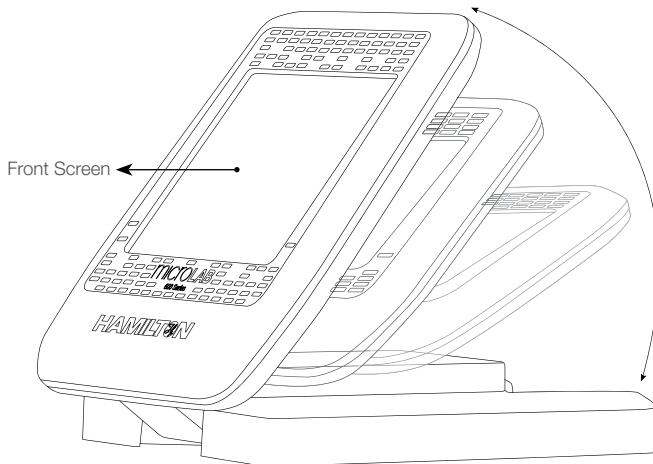

As shown above, the controller can tilt at different angles for user comfort and preference, in addition this controller may also be hung on a wall.

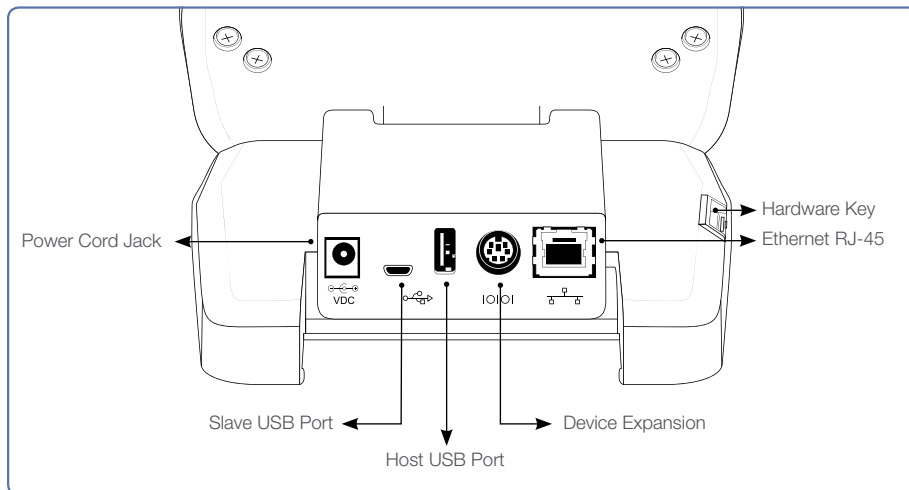
**Figure 2-14 Rear View of the Controller****Power Cord Jack**

This port will only be used when the controller is not attached to the Microlab 600 drive unit. A controller power supply is not shipped with the Microlab 600 as the controller receives power through the Ethernet port when connected to the pump.

**Slave USB Port**

This port could be used to connect the instrument to a PC.

**Host USB Port**

The Host USB port is located on the back of the controller. This port is used for connecting the Microlab 600 to the Printer Kit (p/n 61500-04). The Advanced system is required for use with the printer.

**Device Expansion**

This port will be used to connect future devices that will work with the Microlab 600.

**Hardware Key**

This slot accepts Hamilton specific SD cards for upgrading from the Basic to Advanced unit. Other manufacturer SD cards will fit into the controller but are not compatible with the Microlab 600.

**Ethernet (RJ-45)**

The Ethernet receptacle is located on the back of the controller. This port is used to connect to the drive unit. The controller receives power from the pump via Power Over Ethernet (POE).



Figure 2-15 Final Assembly of the Microlab 600 Instruments

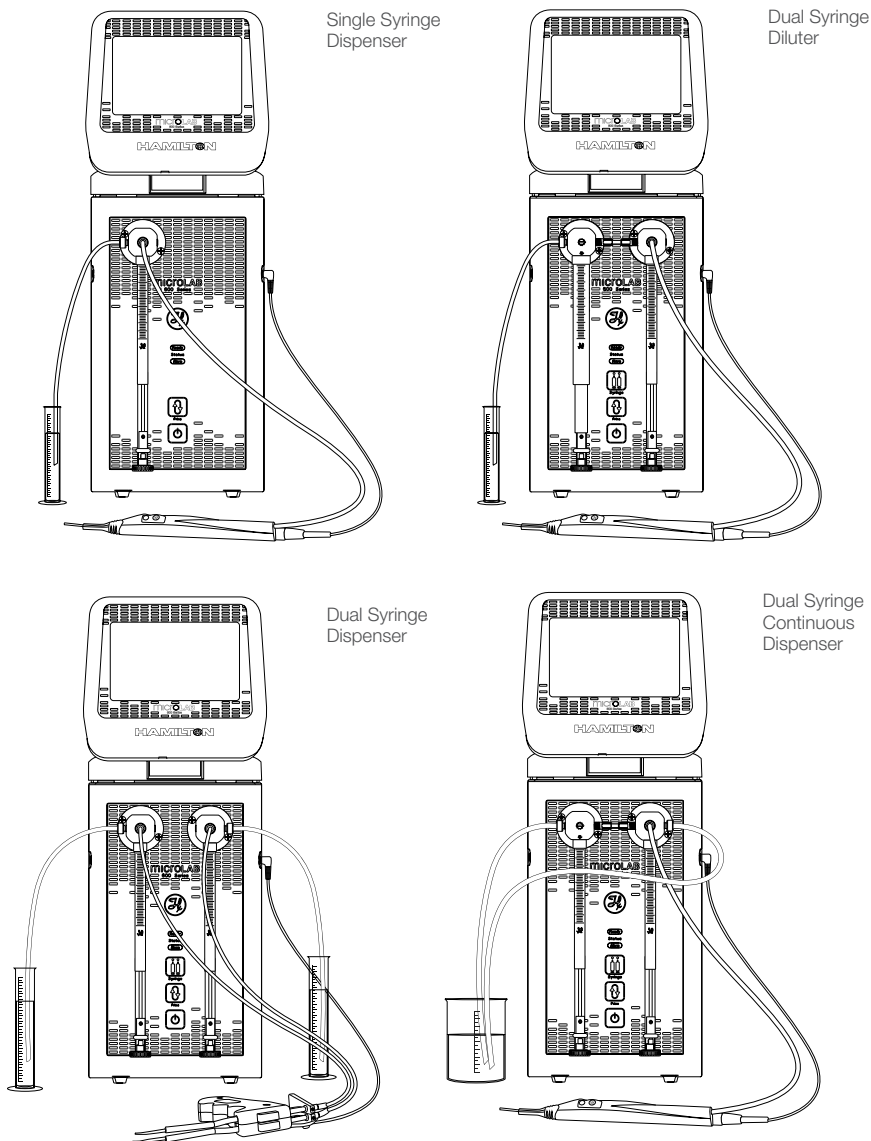

Once the controller unit is installed onto the Microlab 600, the hardware installation is complete and the unit is now ready for operation.



## CHAPTER 3:

# Overview of Screens and Buttons

This chapter will describe the features of the seven major screen types that are used throughout the user interface.

- 3.1 Splash Screen**
- 3.2 Icon Screens**
- 3.3 Run Screens**
- 3.4 Data Entry Screens**
- 3.5 Pop-up Control**
- 3.6 Numeric Keypad**



### 3.1 Splash Screen

This is the boot up screen that will appear when the pump is powered On. The boot up will take approximately 30 seconds. Activity will be indicated by green lights that move across the bottom of the screen. During the boot up the screen will go black for a few seconds. Upon return it is possible to double tap the screen to enter the screen calibration mode referenced in Section 4.3.1.1. Once the system finishes loading, it will start on the Main Menu screen.



### 3.2 Icon Screens

The Icon Screens are used for basic navigation through the user interface. General screens like the Main Menu will most commonly use this screen design to graphically show all possible navigation options.

#### Icon Buttons

These buttons are used to provide the major navigation from function to function within the user interface.



Icon Buttons

### 3.3 Run Screens

This screen enables control and monitoring of all aspects of the pump's activities. Buttons and Icons are used to change Parameters, and Indicators are designed to give current and future status of the pump.



#### Valve Position Indicator

This indicator shows the current valve position and the fluid path. For more details, see Section 3.3.1.

#### Parameter Adjustment Button

This button shows the current dispense setting. The exact function for these buttons will be defined in greater detail in the Quick Start section of this manual.

#### Syringe Position Indicator

This indicator shows the current syringe position graphically and in a numeric volume.

#### Back Button

This button takes the user back to the previous screen.

#### Small Icon Buttons

These buttons provide additional functionality to the Run screen. The exact function for these buttons will be defined in greater detail in the Quick Start section of this manual.

#### Auto Refill Icon

This icon can be toggled "ON" and "OFF". When the icon is labeled "ON" the syringes automatically refill when they are empty. When the icon is labeled "OFF" the syringes will not refill until they are triggered by the hand probe or the "Run" icon.



### Syringe Direction Indicator

This indicator shows the direction the syringe will move in the next step. If there is not an arrow, the syringe will not be moving in the next step.

### Valve Move Indicator

This indicator shows the current valve position and the position where the valve will move in the next step. If the indicator says “Ready” the valve will not move in the next step.

## 3.3.1 Valve Position Indicator Drawings

The Valve Position Indicator will display drawings intended to illustrate the current open fluid path for the universal valve. The gray path with double headed arrows indicates the fluid path that is currently connected to the syringe. The direction the liquid flows through the open fluid path is determined by the direction the syringe is moving. Descriptions and images of the drawings displayed by the Valve Position Indicator are shown for the four pump configurations.

### Single Syringe Dispenser Valve Positions

For a Single Syringe Dispenser, the syringe can be connected to the input tubing or the output tubing. When the valve is in the IN position, liquid can flow from the syringe in or out of the left port. When the valve is in the OUT position, liquid can flow in or out of the center port coming out the front of the valve.

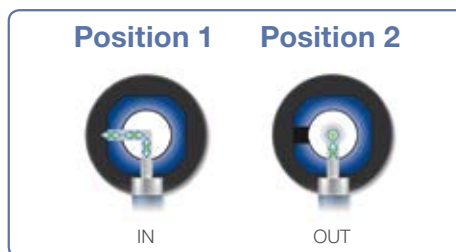

### Dual Syringe Diluter Valve Positions

#### Valve Positions

In this configuration the left and right valves work together as one. The left syringe can be connected to the input tubing or the output tubing which is connected to the front of the right valve. The right syringe can only be connected to the output tubing and does not rotate in this configuration.

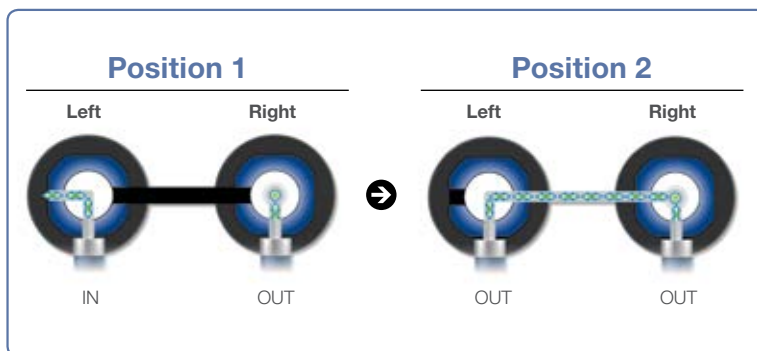

### Dual Syringe Dispenser Valve Positions

The left valve on a Dual Syringe Dispenser is the same as the Single Syringe Dispenser and uses the same drawings and position names. The right valve is a mirror image of the left valve. The IN position connects the right syringe to the reservoir through the right valve port.



**Note:** The left and right valves can move independently of each other, as indicated in the diagram above.

### Continuous Dispenser Valve Positions

In this configuration the left and right valves work together as one. The left syringe can be connected to the input tubing or the output tubing which is connected to the front of the right valve. The right syringe can be connected to the input tubing or the output tubing. It is important to note that when the left valve is rotated to the OUT position the right syringe must be rotated to the IN position before the left syringe can aspirate or dispense liquid.

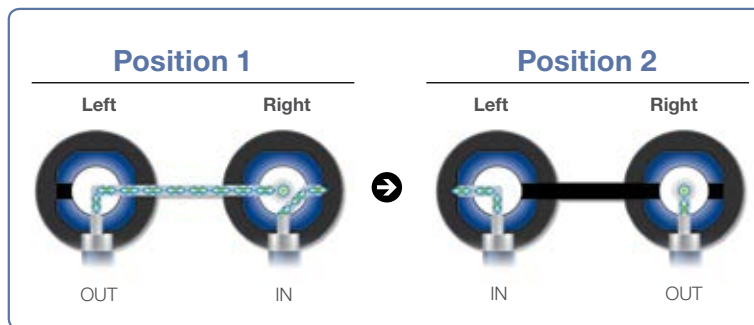

### 3.4 Data Entry Screens

The Data Entry Screens provide a means to input values for several grouped parameters. The values that can be changed are displayed together in a table format. Only the highlighted row from the table can be edited using the Change buttons.



### 3.5 Pop-up Control

The Pop-up Control appears as a modal window within the current screen. All buttons outside of the modal window will be disabled until the "Accept" or "Cancel" button is pressed to close the modal. This control is used to select values from a list of options.

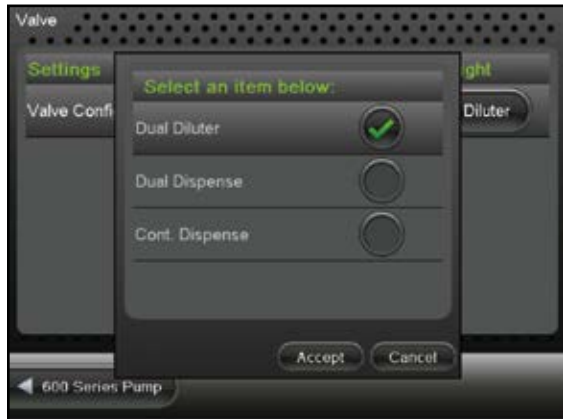

### 3.6 Numeric Keypad

The screen will appear when changing a numeric value. The screen will initially display the current parameter value. There is no need to clear the current value. It will be automatically deleted once a keypad button is pressed.

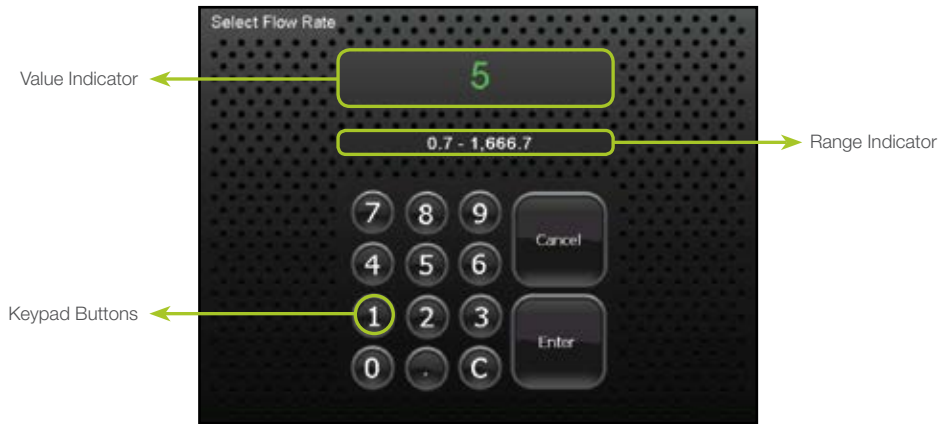

#### Value Indicator

This indicator displays the current value that will be stored when the Enter button is pressed.

#### Keypad Buttons

These buttons are used to add and clear numbers from the Value Indicator.

#### Range Indicator

For most parameters only specific values are acceptable. The Range Indicator displays the valid values for the parameter that is currently selected. If a value is entered outside of that range the font color will turn red until an allowed value is entered.





## CHAPTER 4:

# Basic Controller Setup and Operation

The Basic Microlab 600 Controller features a touchscreen with a custom designed user interface (UI). The UI will enable simple dispensing and diluting operations, for more advanced applications and Custom Method programming purchase the Controller Upgrade Kit (p/n 61500-02).

This chapter will demonstrate how to navigate through the Basic Controller screens as well as a description of the simple dispense and diluting operations. The following topics will be discussed:

## **4.1 User Interface Flow Chart**

## **4.2 Hardware Configuration**

## **4.3 Software Configuration**

## **4.4 Priming the Instrument**

## **4.5 Quick Start**

## **4.6 Utilities**



## 4.1 User Interface Flow Chart

The flow chart below shows the relationship between the major screens in the Microlab 600 Basic User Interface. The Main Menu screen provides access to all other screens within the User Interface. Press the Icon Buttons on the Main Menu screen to navigate through the interface. Press the Back button to return to the previous screen.

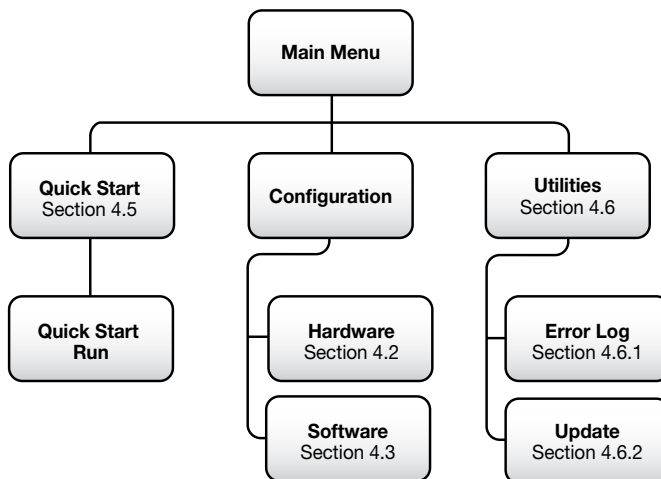

## 4.2 Hardware Configuration

This section will discuss how to properly setup the syringe(s), valve(s) and triggering for the Microlab 600.

### 4.2.1 Syringe Setup

Refer to Chapter 3 for general screen navigation.

#### Syringe Size

This option allows for selection of syringes between 10  $\mu$ L and 50 mL. Once a syringe size is selected, the controller will automatically set the Syringe Speed, Return Steps and Back-off Steps to the recommended value.

### **Syringe Speed**

The syringe speed is programmed in flow rate ( $\mu\text{L}/\text{sec}$ ). The default setting for speed will be automatically selected when the Syringe Size is changed. When changing the syringe speed the system will recommend two alternative speeds in addition to the default speed. If none of the speeds are desirable, select the custom option to define a new flow rate. If the speed selected is faster than the default it may cause the instrument to stall. The allowable flow rates are displayed in Table 2-5.

### **Initialize Flow Rate**

This is the same as the syringe speed however this speed is used when the pump is being initialized.

### **Return Steps**

Return steps are used to take the mechanical slack out of the syringe drive. The defaults should be used unless otherwise instructed by a representative of Hamilton Company or an authorized distributor for Hamilton Company.

### **Back-off Steps**

When the pump initializes it drives the syringes to the top of their stroke until resistance is felt. Then the pump moves back from that resistance a defined distance dictated by the Back-off Steps. This new position is set as the zero point. Some syringes have more material at the tip of their plunger so they require more Back-off Steps. The defaults should be used unless otherwise instructed by a representative of Hamilton Company or an authorized distributor for Hamilton Company.

## **4.2.2 Valve Setup**

### **Valve Type**

The valve type must match the actual valve and tubing that is connected to the front of the syringe pump. The valve type is used to properly position the valve for a given application. A mismatched configuration can result in the syringe dispensing to a blocked port which has the potential to destroy the valve and/or the syringe.

## **4.2.3 Triggering**

The Microlab 600 has two probe receptacles, one on the left and one on the right side of the instrument. The default is to accept trigger signals from either the left or the right trigger port. If desired, it is possible to set the instrument to only accept triggers from the left or right side of the instrument. When a side is selected, trigger signals from the opposite side will be ignored.





## 4.3 Software Configuration

In the Software Configuration, users have the ability to modify settings within the Controller, view Software Version Numbers and the Pump Version Numbers. This section provides a discussion of these topics.

### 4.3.1 Controller

In the controller settings users have the ability to modify the following:

- ▶ 4.3.1.1 Screen Calibration
- ▶ 4.3.1.2 Screen Power Off
- ▶ 4.3.1.3 RAM Used
- ▶ 4.3.1.4 System Trace Logging
- ▶ 4.3.1.5 System Date and Time (Advanced Controller Only)
- ▶ 4.3.1.6 Internal and Removable Storage Used (Advanced Controller Only)
- ▶ 4.3.1.7 MAC Address (Advanced Controller Only)
- ▶ 4.3.1.8 Language (Advanced Controller Only)

#### 4.3.1.1 Screen Calibration

The controller touchscreen is calibrated before it leaves Hamilton Company. If the clicked area on the touchscreen does not seem to be aligned with the image on the screen it is probably time to recalibrate the screen.

**Step 1.** To reset the instrument calibration, select the Software icon from the Configuration screen and then select Controller. Toggle down to the Screen Calibration option and press the Calibrate change button. This screen right should appear.

**Step 2.** Press the center of the cross.

**Step 3.** The cross will move to different locations on the screen. Each time the cross stops moving press the center.

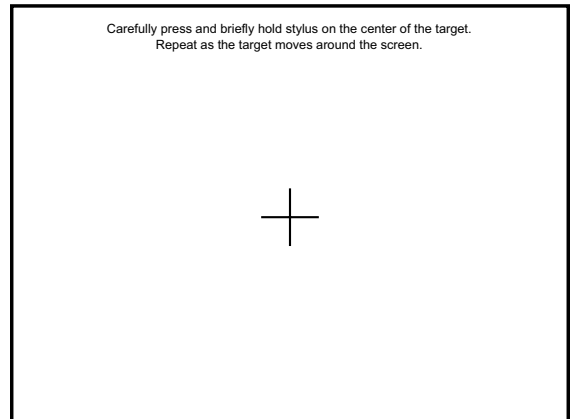

**Step 4.** Once all five positions have been recorded, press anywhere on the screen to store the calibration values.

If the calibration is so far off that it is impossible to navigate to Screen Calibration, as described in Step 1, it is possible to get to the calibration program during system start up. Turn the instrument Off and then On. The initial splash screen will be displayed, followed by a completely black screen. After a few seconds the splash screen will appear again. Double click the screen as indicated to enter the calibration program.



#### 4.3.1.2 Screen Power Off

The Microlab 600 touchscreen is designed to turn off after an extended period of inactivity. The default setting for the power off is 10 minutes. If desired, the power off time can be increased through this selection.

#### 4.3.1.3 RAM Used

This is an indicator of how much RAM is used on the controller.

#### 4.3.1.4 System Trace Logging

This will have a default to Off. When this is turned on it will record critical information in the Error Log to aid in troubleshooting the instrument by Hamilton employees. For more information on the Error Log reference Section 4.6.1.

#### 4.3.1.5 System Date and Time (Advanced Controller Only)

Using the toggle buttons the user can highlight and select the System Date and then use the change buttons to set the appropriate date. Likewise the user can repeat this process for the System Time.



#### 4.3.1.6 Internal and Removable Storage Used (Advanced Controller Only)

These are indicators for the percent memory used for the system memory and the SD card.

#### 4.3.1.7 MAC Address (Advanced Controller Only)

This is the unique identifier assigned to the instrument for connecting to a network.

#### 4.3.1.8 Language (Advanced Controller Only)

This is used to select the appropriate language. When this button is pressed the user will be directed to a screen that has the different languages represented by flags. The user may use the toggle to see all languages. Available languages include English, French, Italian, Portuguese, Spanish, German, Chinese, Japanese, Korean and simplified Chinese. The default setting will be English.

The button in the lower right corner of the screen toggles Hide on and off. When Hide is turned off the language screen will show up every time the instrument is turned on. This allows for multiple users that speak different languages to all use the same instrument in their native language. If Hide is turned on the language screen is only accessed through the Configuration menu.

### 4.3.2 Versions

This option displays the software version for the Microlab 600 controller and all of the Wizards and Components that are installed on the controller.

### 4.3.3 600 Series Pump

This option shows the pump details. This is information stored in the pump and is independent of swapping out the controller.

#### **Calibration Date**

This date is manually adjusted by the user each time the instrument calibration occurs.

#### **Firmware Runtime and FPGA Versions**

These are the version numbers for the firmware that runs on the pump.

#### **Syringe Cycle Count**

This option displays a running total of the number of syringe strokes the pump has accumulated over its entire life. A complete stroke is recorded when the syringe drive has traveled a distance of 60 mm or the equivalent of completely filling or emptying a syringe. This is done so that a series of small movements does not artificially increase the cycle count. For a dual syringe system, the cycle count is displayed as two numbers separated by a colon. The number on the left corresponds to the left syringe and the number on the right corresponds to the right syringe.

## Serial Number

This is a unique identification number given to each Microlab 600.

## DHCP (Advanced Controller Only)

This Microlab 600 controller communicates with the pump using a static IP address. A static IP address is also used when connecting the Microlab 600 to a PC. To connect the Microlab 600 to most corporate networks it is required to change the Microlab 600 to a Dynamic Host Configuration Protocol (DHCP). When in DHCP mode the Microlab 600 will obtain a dynamic IP address for the corporate server. During this time it will not be able to connect to the Microlab 600 controller. If the corporate server does not return a valid IP address after 60 seconds, the Microlab 600 will automatically switch back to a static IP address until the power is cycled again. The default DHCP setting is Off.

## 4.4 Priming the Instrument

This section will describe how to properly prime the Microlab 600 before running a method.

- Step 1.** Decide which side or sides of the instrument are to be primed. Use the Syringe Selector button to select the syringes to prime as described in 2.3.1. The selected syringes will have a blue LED illuminated above them. The Syringe Selector button is not present on single syringe instruments.
- Step 2.** Make sure your fill tubing is in the reservoir and dispense tubing is directed towards a waste container. Tubing clips may be required to secure the tubing to the vessel.
- Step 3.** Press and release the Prime button. The syringes that were selected using the Syringe Selector button should move to the top of their stroke and then continuously prime until the Prime button is pressed again.

 **Note:** If the valves were not already initialized, they will initialize before the syringe(s) move which could result in a slight delay before the syringe(s) begin moving.

-  **Note:** Each dual syringe setup will prime differently to optimize the priming and minimize waste.
- ▶ Each Dual Syringe Diluter setup will prime both left and right syringes. Make sure the dispense tubing from the hand probe is submersed in the diluent reservoir to prime the right syringe.
  - ▶ The Continuous Dispenser will oscillate syringes so one syringe will fill while the other is dispensing.

- Step 4.** Once all the air is flushed from the system it is fully primed. Press the Prime button when the syringes are near the top of their stroke to stop the priming.





## 4.5 Quick Start

When the Quick Start button is selected from the Main Menu the user will be taken directly to the Run screen. From this screen the user can enter a dispense volume for the left and right syringe, using the Parameter Adjustment button. The syringe(s) will fill and dispense the selected volume when the hand probe is triggered. Prior to running a method, the instrument must be properly configured and primed. For information on how to do this, review Sections 4.2–4.4. There are four basic instrument configurations including Single Syringe Dispenser, Dual Syringe Diluter, Dual Syringe Dispenser and Continuous Dispenser. Reference Figures 2-7 through 2-10 for more details. Below is a discussion of the steps each of the configurations will perform.

### 4.5.1 Single Syringe Dispenser

- Step 1.** The syringe will fill from the input reservoir to the volume specified by the Parameter Adjustment button, see Section 3.3. This step will execute when the Run icon is pressed on the controller or the trigger is pressed on the hand probe.
- Step 2.** Position the dispense tubing over the destination container. Trigger the next step with the Run icon or the trigger on the hand probe.
- Step 3.** The syringe will dispense the volume specified by the Parameter Adjustment button, see Section 3.3 to the output tubing through the hand probe.
- Step 4.** Step 1 will be repeated. If the Auto Refill icon, see Section 3.3, is set to ON this step will execute automatically. If the icon is set to OFF then the Microlab 600 will wait for a trigger.

☆ **Important!** The dispense volume can be changed at any time. The pump will automatically recalculate to bring in more liquid if needed.

### 4.5.2 Dual Syringe Diluter

- Step 1.** Place the tip of the hand probe into the sample and press the trigger.
- Step 2.** The left syringe will fill with diluent from the input reservoir to the volume specified by the left Parameter Adjustment button see Section 3.3. The right syringe will aspirate sample into the hand probe according to the right Parameter Adjustment button.



☆ **Important!** The volume of the sample aspirated should not exceed the 80% of the internal volume of the dispense tubing. This will avoid contamination of the right syringe with the sample. Tubing volumes and custom length tubing is listed in Appendix B.

- Step 3.** The hand probe should be positioned over the destination container. Trigger the next step with the Run icon or the trigger on the hand probe.
- Step 4.** The left and right syringe will dispense their entire volume through the dispense tubing and out the hand probe. The sample will be dispensed followed by the diluent which washes out the tubing for the next sample.
- Step 5.** If the Auto Refill icon is set to ON the left syringe will automatically refill with diluent. If the icon is set to OFF then the Microlab 600 will wait for a trigger at which time Step 1 will be repeated.

### 4.5.3 Dual Syringe Dispenser

The steps described in Section 4.5.1 will be the same with this configuration. The only difference is that both the left and right syringes will fill and dispense according to the values entered for the Parameter Adjustment buttons.

### 4.5.4 Continuous Dispenser

The steps described in Section 4.5.1 will be the same with this configuration. The only difference is that the left syringe will fill while the right syringe is dispensing or the right syringe will fill while the left syringe is dispensing. This setup will ensure that one syringe is always filled with reagent, resulting in decreased time between dispenses.



## 4.6 Utilities

This section focuses on the Utilities of the instrument. A discussion of the Error Log files and system Update follow.



### 4.6.1 Error Log

The Error Log provides a listing of the most recent errors recorded by the controller. The Error Log may be exported and sent to Hamilton Company to review and aid in troubleshooting. Additional Hamilton technical support is available at:

#### In the United States and Canada:

##### Hamilton Company Inc.

4970 Energy Way  
Reno, Nevada 89502  
USA

##### Customer Service

(888) 525-2123

##### Technical Support/Service

(800) 648-5950

##### Outside the U.S.

+1 (775) 858-3000

#### In Switzerland:

##### Hamilton Bonaduz AG

Via Crusch 8  
Ch-7402 Bonaduz  
Switzerland

##### Customer Service

+41 81-660-60-60

Fax +41 81-660-60-70



### 4.6.2 Update

The most current version of the Microlab 600 Firmware/Software will be posted at [www.hamiltoncompany.com/microlab600/software](http://www.hamiltoncompany.com/microlab600/software). Select the latest version of software to update an older Microlab 600 with current Firmware/Software.

Download the .ZIP update file and transfer it to an SD card. Transfer the entire file; do not extract the files. This process will be handled by the Microlab 600 controller. Insert the SD card into the controller, and power on the Microlab 600 instrument. Enter the Utilities screen, and press the Update button. Press Start to begin the update. Follow the instructions on the screen to complete the update.

## CHAPTER 5:

# Care and Maintenance

This chapter contains instructions for routine maintenance procedures for the Microlab 600, which includes the following topics:

- 5.1 Yearly Maintenance**
- 5.2 Instrument Calibration**
- 5.3 Deciding When to Clean the Microlab 600**
- 5.4 Cleaning the Fluid Path**
- 5.5 Cleaning the Exterior of the Microlab 600**
- 5.6 Storing the Microlab 600**
- 5.7 Replacing Batteries**



## 5.1 Yearly Maintenance

It is recommended that the Microlab 600 be sent to a service center for cleaning and lubrication on an annual basis. Upon receiving the instrument a technician will evaluate it to make sure it is in good working order. The belts will be replaced and the lead screw and shaft will be cleaned and replaced if necessary. The lead screw and shaft will be lubricated. Finally, the instrument will be retested and recertified for calibration.

## 5.2 Instrument Calibration

The design and programming of the Microlab 600 eliminates the need for adjustment of the instrument's calibration. When the syringes and valves are installed the instrument performs an initialization. This initialization orients the valves and the syringes with the optical encoders that are permanently mounted to each drive motor. The valve initialization consists of rotating the valve more than 360 degrees to identify a calibration location on the optical encoder. When this location is identified the exact valve location is known. The syringe initialization consists of driving the syringe to the top of its stroke. Top of stroke is determined when the syringe drive stalls due to the force of the plunger pressing against the end of the barrel. The pump then backs off a defined distance and sets that point as the zero volume. This method of initialization accommodates for tolerances in the length of the syringe and eliminates the need for manual adjustment.

Many companies require that instrumentation, including the Microlab 600, be validated on a monthly, semi-annual or annual basis. The instrument can be sent to Hamilton Company for recertification at any time. Simply contact Hamilton Customer Service to obtain a Return Materials Authorization (RMA) number.

Hamilton's validation procedure for accuracy and precision are performed according to the ANSI standard XY. There are instructions on validating the Microlab 600 on our website at [www.hamiltoncompany.com/microlab600](http://www.hamiltoncompany.com/microlab600).

 **Note:** Sending the Microlab 600 in for non-warranty service will be charged to the customer.

## 5.3 Deciding When to Clean the Microlab 600

Cleaning the Microlab 600 is dependent on how the instrument is used with respect to the duration of use and types of chemicals entering the system.

We recommend that you clean the instrument daily. The tubing and syringes should be purged and primed at the end of each experiment and/or each work shift. To clean the Microlab 600, flush the system with Hamilton Syringe Cleaning Concentrate (p/n 18311), ethanol or with 10% chlorine bleach and deionized water solution. Avoid using caustic or acidic cleaning solutions.

☆ **Important!** Leave the syringe and tubing filled with deionized water during prolonged inactivity. This is important if you are using buffers or other salt solutions which could accumulate or crystallize in the system. If buffers or other salt solutions are left in the fluid path overnight, crystals may form and damage the syringe plunger tip.

## 5.4 Cleaning the Fluid Path

For highly critical applications the Microlab 600 should be cleaned on a regular basis. Use Hamilton Syringe Cleaning Concentrate or ethanol to clean the fluid path. Steps on cleaning the fluid path are listed below.

When the tubing and syringes come in contact with contaminated or hazardous samples, follow safe laboratory practices in selecting and using a cleaning fluid to flush out the tubing and syringes.

⚠ **WARNING!** Follow laboratory safety procedures if the Microlab 600 instrument comes in contact with hazardous materials.

Use a cleaner that is compatible with the fluids previously run through the system. Depending on the sample that is being run, deionized water, urea, ethanol or 10% chlorine bleach and deionized water solution may be used as a cleaning fluid. See Appendix D for chemical compatibility with the Microlab 600.

- Step 1.** Prepare a reservoir of cleaning fluid and place the fill tubing in the cleaning fluid reservoir. Use a tubing clip to secure the tubing in the reservoir vessel.
- Step 2.** Place the hand probe over the cleaning fluid reservoir.
- Step 3.** Press the Prime button to begin the prime cycle.
- Step 4.** Continue priming the system until the fluid path is clean. The number of cycles required to clean the fluid path will depend on the size of the syringes and the level of contamination present in the system. A good estimate is 5–10 cycles of the syringe or 5–10 times the internal volume of the fill and dispense tubing.



- Step 5.** When the fluid path is clean, press the Prime button to stop the priming cycle.
- Step 6.** Move the fill tubing from the cleaning fluid reservoir and place it into a reservoir of deionized water.
- Step 7.** Press the Prime button to continue the prime cycle.
- Step 8.** Continue priming the system until the fluid path is free of all cleaning fluid. Press the Prime button to stop the priming cycle. Dispense the rinse fluid into a waste container.

The system is now clean and ready for use.

## 5.5 Cleaning the Exterior of the Microlab 600

The Microlab 600 housing is moderately inert to chemical exposure. However, some chemicals may discolor the surface of the unit.

If a spill occurs on the exterior of the instrument, wipe the surface immediately. Wash the surface using a damp cloth with soap and water. Then dry the area. Make sure liquids do not enter the interior of the Microlab 600.

To disinfect the exterior surface, wipe it down with 10% chlorine bleach and deionized water solution. Then dry the area.

 **Note:** The cleaning guidelines presented here are meant as guide only. If applications require different cleaning solutions, contact Hamilton Company for more information.

## 5.6 Storing the Microlab 600

For long-term storage, prime and purge the system with methanol to facilitate drying. Remove the tubing and syringes. Place the syringes in their original boxes. Cover the instrument to protect it from damage.

## 5.7 Replacing Batteries

In the controller there is a battery that is used to maintain the date and time in the event that power is lost to the instrument. Should the battery fail, the controller will need to be sent in for service. The battery should have a life of 10 or more years.

## CHAPTER 6:

# Troubleshooting

This chapter includes information on troubleshooting the Microlab 600, which includes the following topics:

- 6.1 Error Message Code Guide**
- 6.2 Troubleshooting Guide**
- 6.3 Getting Technical Support**
- 6.4 Returning Instruments for Repair**



## 6.1 Error Code

The controller will log the errors that have occurred with the pump. This will be stored as a file on the pump that can be exported and sent to Hamilton Company to review and aid in troubleshooting.

## 6.2 Troubleshooting Guide

This section contains information on troubleshooting the Microlab 600 instrument.

**Table 6-1 Troubleshooting Guide**

Problem	Possible Causes	Corrective Action
Instrument does not power On	▶ Disconnected power cord or faulty power outlet	▶ Connect power cord and check power source
	▶ Faulty power supply	▶ Check the power supply to see if the light is on when plugged in
Instrument functions normally, but display screen fails to illuminate	▶ Controller unit not plugged into drive unit	▶ Check to see that the controller unit is plugged into the drive unit
	▶ Faulty LCD	▶ Call the Hamilton Service Department ▶ The POE may be turned Off
Instrument does not fill or dispense	▶ Faulty or blocked tubing; blocked or leaky fluid path	▶ Check tubing, valve and syringes for blockage, crimps, or loose fittings. If damaged replace the appropriate component. If loose tighten the appropriate component.
	▶ Incorrect tubing or syringe connections	▶ Check that appropriate tubing, fittings and syringes are used and that they are fingertight
	▶ Faulty controller	▶ Call the Hamilton Service Department
	▶ Non-functional syringe drive(s)	▶ Call the Hamilton Service Department
	▶ Valves do not rotate (valve drives are not engaged or valve is faulty)	▶ Remove and reinstall valve or replace valve



Problem	Possible Causes	Corrective Action
Instrument gives inaccurate or imprecise results	▶ Air exists in the fluid path	<ul style="list-style-type: none"> <li>▶ Check to see that tubing ends are totally submerged in reagent bottles</li> <li>▶ Check to see that tubing connections are tight; replace if necessary</li> <li>▶ Check to see that the syringe is installed correctly and that it is not leaking</li> <li>▶ Replace worn or leaking valves or tubing</li> <li>▶ Reduce the syringe drive speed to eliminate cavitation problems</li> </ul>
	▶ Incorrect size of dispense tubing used with syringe	<ul style="list-style-type: none"> <li>▶ Check for correct tubing and fittings</li> <li>▶ Use small tapered tubing (18 gauge) for small dispense volumes</li> </ul>
Small air gap appears at tip of probe tubing after final aspiration	▶ Dirty tubing	▶ Change or clean the tubing
	▶ Improper aspiration	▶ Lower the aspiration speed
Persistent air or leaks in the fluid path	▶ Cavitation is occurring; syringe drive speed is too high for the current liquid	▶ Reduce syringe drive speed, use lower drive speeds for viscous liquids
	▶ Loose, worn, or incorrect tubing fittings	▶ Hand-tighten the fittings or replace old tubing with new or correct-size tubing
	▶ Damaged syringe plunger tip	▶ Replace plunger or syringe
	▶ Damaged valve	▶ Replace valve
Unit is overheated	▶ Inadequate ventilation, room temperature too high, or duty cycle too high	<ul style="list-style-type: none"> <li>▶ The unit is overheated, power it Off and allow it to cool down</li> <li>▶ Resume use at a lower duty cycle</li> <li>▶ See Appendix A Technical Specifications</li> </ul>



## 6.3 Getting Technical Support

If a problem persists even after attempts to correct it, contact Hamilton Company Technical Support or Service Department. To expedite service, please have the instrument part number and serial number ready and available. Please be able to provide application specific information (syringe sizes, drive speeds and liquids).

### In the United States and Canada:

#### **Hamilton Company Inc.**

4970 Energy Way  
Reno, Nevada 89502  
USA

#### **Customer Service**

(888) 525-2123

#### **Technical Support/Service**

(800) 648-5950

#### **Outside the U.S.**

+1 (775) 858-3000

### In Switzerland:

#### **Hamilton Bonaduz AG**

Via Crusch 8  
Ch-7402 Bonaduz  
Switzerland

#### **Customer Service**

+41 81-660-60-60

Fax +41 81-660-60-70

## 6.4 Returning Instruments for Repair

Before returning an instrument to Hamilton please contact Hamilton Company and request a Returned Materials Authorization number (RMA).

 **Note:** Do not return instruments to Hamilton Company without an RMA number. This number assures proper tracking of your instrument. Instruments that are returned without an RMA number will be sent back to the customer without being repaired.

 **Biohazard:** The Microlab 600 instrument **MUST** be decontaminated before it is returned to Hamilton Company. To decontaminate the instrument, remove health hazards, such as radiation, infectious diseases, corrosive agents, etc. Provide a complete description of any hazardous materials that have been used with the instrument.

 **Biohazard:** Hamilton Company reserves the right to refuse a return shipment of any Hamilton product that has been used with radioactive, microbiological substances or any other material that could be hazardous to Hamilton employees.

 **Important!** Do not return syringes, tubing or valves with your instrument. Hamilton Company will assume that they pose a health hazard and will destroy them.





# Appendices

## Appendix A—Technical Specifications

### Technical Specifications

Accuracy	Refer to Table 2-6
Precision	Refer to Table 2-6
Syringe drive mechanism	1.8° stepper motor with variable volumetric flow rate
Speed	Refer to Table 2-5
Syringe size	10 µL–50 mL
Volume range	1.0 µL–50 mL
Fluid path	Borosilicate, PTFE, CTFE
Program memory	2 GB (only with purchase of the controller Upgrade Kit #1 p/n 61500-02)
Communication type	Ethernet, 10/100 BASE-T
Power requirements	100–240 V 1.5A max 50/60 Hz
Power rating	24 VDC, 2.5A
Certifications	CE, CSA Installation category I and Pollution degree 2 <sup>1</sup>
Dimensions	7 x 5.5 x 10.5 inch (177.8 x 139.7 x 266.7 mm) Excluding controller
Weight	13 lbs (5.9 kg)
Shipping dimensions	15.25 x 14.5 x 15.25 inches (387.4 x 368.3 x 387.4 mm) Excluding controller
Shipping weight	17 lbs (7.7 kg)
Operating temperature	41–104°F (5–40°C)
Storage temperature	-4–158°F (-20–70°C)
Humidity range	20–90% non-condensing
Compliance	FCC Part 15, Class B EMC: EN 61326-1, Class B

#### Indoor Operation and Use Only

<sup>1</sup>—Per Section 3.6.6.2 “pollution degree 2” is defined as “normally only non-conductive pollution occurs (addition of foreign matter, solid, liquid or gaseous (ionized gasses), that may produce a reduction of dielectric strength or surface resistivity).” Occasionally, however a temporary conductivity caused by condensation must be expected.





## Appendix B—Replacement Parts and Accessories

**Table B-1 Controller Upgrade Kits**

Upgrade Kit	Part Number
Upgrade Kit #1 (Basic to Advanced)	61500-02
Upgrade Kit #2 (Computer Controlled)	61500-03

The controller upgrade kit consists of the following parts:

- ▶ **SD card**—Installs into the controller to add memory to the controller and to enable the advanced functionality of the pump (not in Upgrade Kit #2).
- ▶ **USB adapter**—The SD Card installs into this adapter allowing the contents of the card to be accessed through a standard USB port (not in Upgrade Kit #2).
- ▶ **Software CD**—This CD contains an Application Programming Interface (API) in the form of several .DLL files. These files can be used to control the pump in most Windows® based programming languages that are compatible with Microsoft® .NET 2.0 framework. The CD also contains a programmer manual that defines the commands contained in the API. Finally the CD contains example programs written in LabVIEW™, Visual C#® and Visual Basic®. These programs are intended to give an experienced programmer a quick example of how to connect to the pump and call a few commands.

**Table B-2 Replacement Syringes**

Syringe Size	Part Number	Syringe Size	Part Number
10 µL	59000-05	1.0 mL	59000-35
25 µL	59000-10	2.5 mL	59000-40
50 µL	59000-15	5.0 mL	59000-45
100 µL	59000-20	10 mL	59000-50
250 µL	59000-25	25 mL	59000-55
500 µL	59000-30	50 mL	59000-60



**Table B-3 Syringe Cleaning Concentrate**

Cleaning Concentrate Volume	Part Number
70 mL	18310
500 mL	18311

To use the cleaning concentrate dilute to 25% with deionized water to clean the fluid path. To clean the exterior of the instrument dilute the cleaning concentrate to 10% with deionized water.

**Table B-4 Replacement Valve Parts**

Valve Assembly Description	Part Number
Left Valve Assembly	60676-01
Right Valve Assembly	60675-01
Valve Cross Tube Assembly	61498-01
Valve Plug	61729-01

**Table B-5 Replacement Fill and Dispense Tubing Assemblies for Concorde CT and Dual Push Button Hand Probes**

Gauge	Type	Length	Internal Volume	Part Number
18	Fill Tubing	48" (1219 mm)	1.15 mL	61615-01
18	Dispense Tubing	54" (1372 mm)	1.29 mL	240134
18	Fill Tubing	Custom Length	0.94 $\mu$ L/mm	1174-02
18	Dispense Tubing	Custom Length	0.94 $\mu$ L/mm	1173-02
12	Fill Tubing	48" (1219 mm)	4.57 mL	61614-01
12	Dispense Tubing	54" (1372 mm)	5.15 mL	240133
12	Fill Tubing	Custom Length	3.75 $\mu$ L/mm	1172-02
12	Dispense Tubing	Custom Length	3.75 $\mu$ L/mm	1171-02



**Table B-6 Continuous Fill Tubing Assemblies**

Gauge	Type	Internal Volume	Part Number
18	Continuous Fill Tubing	0.94 $\mu\text{L}/\text{mm}$	61491-02
12	Continuous Fill Tubing	3.75 $\mu\text{L}/\text{mm}$	61491-01

**Table B-7 Accessories**

Description	Part Number
Tubing Clips (5/pk)	88990
Accessory Holder	61710-01
Cable Management System <sup>1</sup>	65160-01

<sup>1</sup>—This should only be used with the Disposable Tip Hand Probe (p/n 63960-02)

**Table B-8 Basic and Advanced Manuals**

Description	Part Number
Basic Manual English	61440-01
Advanced Manual English	61441-01

 **Note:** Foreign language manuals are available for download at [www.hamiltoncompany.com/microlab600](http://www.hamiltoncompany.com/microlab600).



**Figure B-1 Power Supply and Power Cord Assembly Diagram**

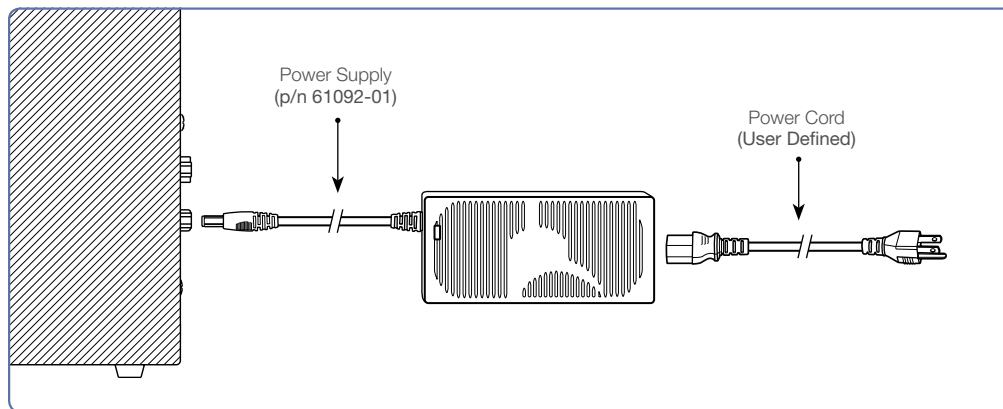





The Microlab 600 uses an external power supply like a computer laptop. The power supply is common to all Microlab 600 instruments and handles 110–220 VAC. When the Microlab 600 is purchased the correct power cord must be selected for the country where the instrument will be used.

**Table B-9 Power Supply**

Description	Country	Part Number
Power Supply	Universal	61092-01

**Table B-10 Replacement Power Cords**

Power Cord Type	Country	Diagram of Plug	Part Number
CH	Switzerland		355008
Standard CEE 7/7	Continental Europe, Russia, Schuko		3892-01
Standard AS 3112	Australia, New Zealand, Argentina, China		3892-02
Standard BS 1363	UK, Ireland, Malaysia, Middle East		3892-03
Standard NEMA 5-15p	USA, Canada, Mexico, Central America, Brazil, Japan		3892-05

**Figure B-2 Thumbscrew Assembly Parts**

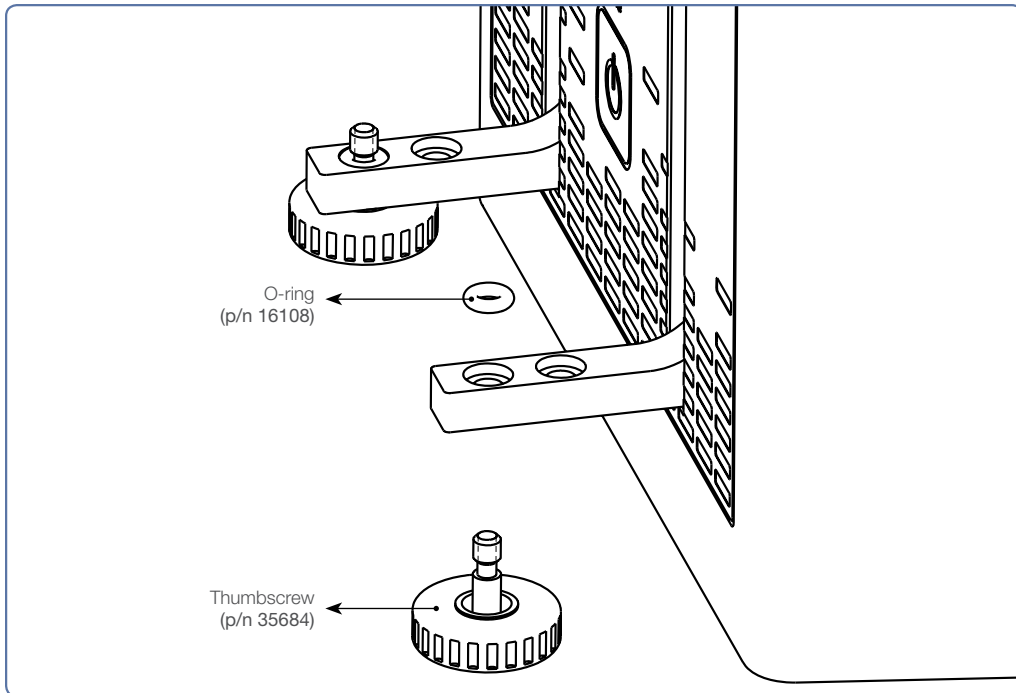



## Appendix C—Hand Probes and Foot Switch

**Table C-1 Hand Probes and Foot Switch Parts**

Description	Part Number
Concorde CT Hand Probe	61401-01
Dual Push Button Hand Probe	62541-01
Disposable Tip Hand Probe	63960-01
50 $\mu$ L, non-sterile ClickSure tips, 960 tips racked	235537
50 $\mu$ L, non-sterile ClickSure tips, 960 bulk	235543
50 $\mu$ L, sterile ClickSure tips, 960 tips racked	235536
1 mL, non-sterile ClickSure tips, 960 tips racked	235539
1 mL, non-sterile ClickSure tips, 960 bulk	235545
1 mL, sterile ClickSure tips, 960 tips racked	235538
Large Volume Disposable Tip Hand Probe (5 mL)	62575-01
5 mL Disposable Tips (250/pk)	75702
Foot Switch	62576-01
Probe Extension Cable 3 Feet	63397-01

### C-1 Concorde CT Hand Probe

The Concorde CT Hand Probe is a single dispense tube pipette probe that features a slim, comfortable design. This probe is used with single syringe dispensers, dual syringe diluters and continuous dispensers. Dispense tubing will connect to the pump and run through the Concorde CT Hand Probe. The probe jack will fit into the probe receptacle on the drive unit. This probe accommodates either 12 or 18 gauge dispense tubing. See Table B-5 in Appendix B for dispense tubing part numbers.

If there are applications where needles are required for use with the Microlab 600 the tip of the Concorde CT Hand Probe may be converted to a luer lock termination using the Luer Lock Conversion Kit (p/n 58381-01).

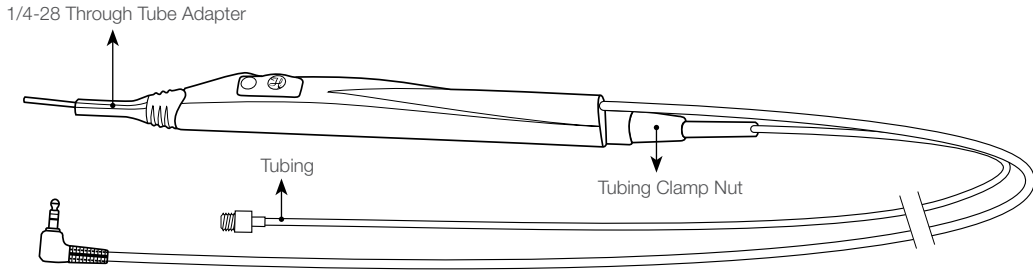

**Figure C-1 Concorde CT Hand Probe****C-2 Dual Push-Button Hand Probe**

The Dual Push-Button Hand Probe holds two dispense tubes and features a pistol grip design with a push-button actuator. This probe is used with the Dual Syringe Dispenser configuration. It will accommodate either 12 or 18 gauge dispense tubing assemblies. It can independently extend each dispense tube into the dispense vessel. See Table B-5 in Appendix B for dispense tubing part numbers.

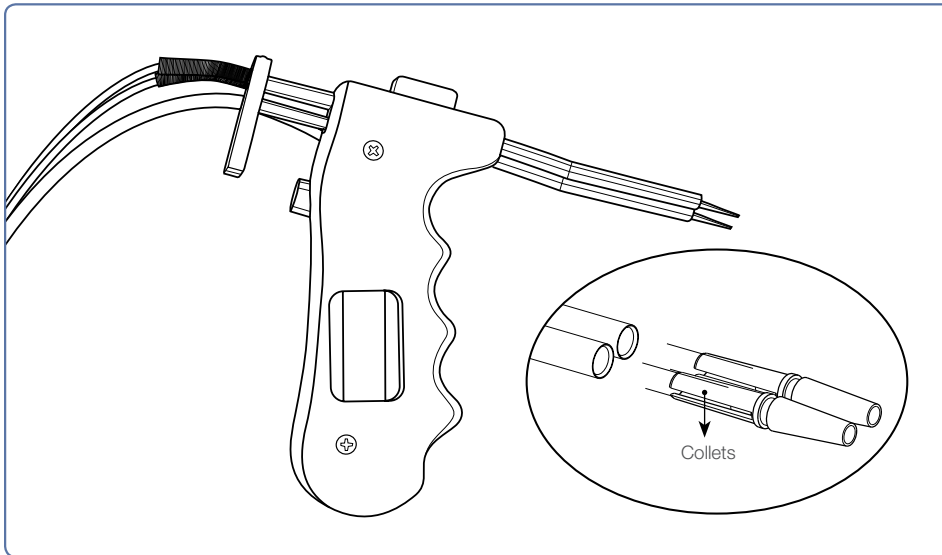
**Figure C-2 Dual Push-button Hand Probe and Tubing Collet**

**Note:** The 18 gauge tubing requires the use of a tubing collet to hold the smaller tubing firmly. The tubing should be threaded through the probe to the desired length. Then the tubing collet should slide over the tubing and be slipped into the metal tip of the hand probe. As the collet is pressed into the metal tube it will grab on the tube to hold it firmly in place.

### C-3 Disposable Tip Hand Probe

The Disposable Tip Hand Probe is a single dispense tube pipette that features ClickSure® tips and a tip ejector. This is an optional hand probe for use with the Dilution and Pipette Wizards.

**Figure C-3 Disposable Tip Hand Probe**

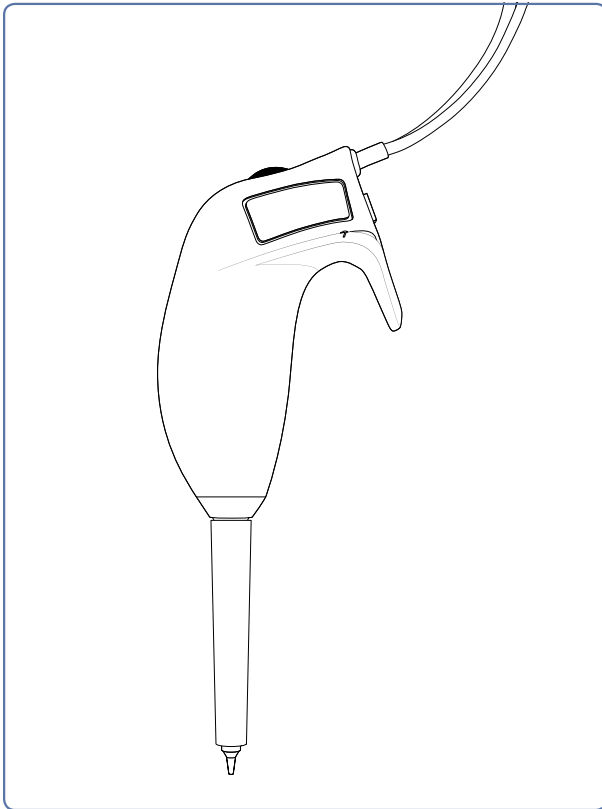

### C-4 Large Volume Disposable Tip Hand Probe

This is an optional hand probe with a single dispense tube designed to accommodate highly viscous samples, such as motor oil and also large volume samples from 1–5 mL. This probe features a 5 mL disposable tip that will minimize sample carryover.

**Figure C-4 Large Volume Disposable Tip Hand Probe**

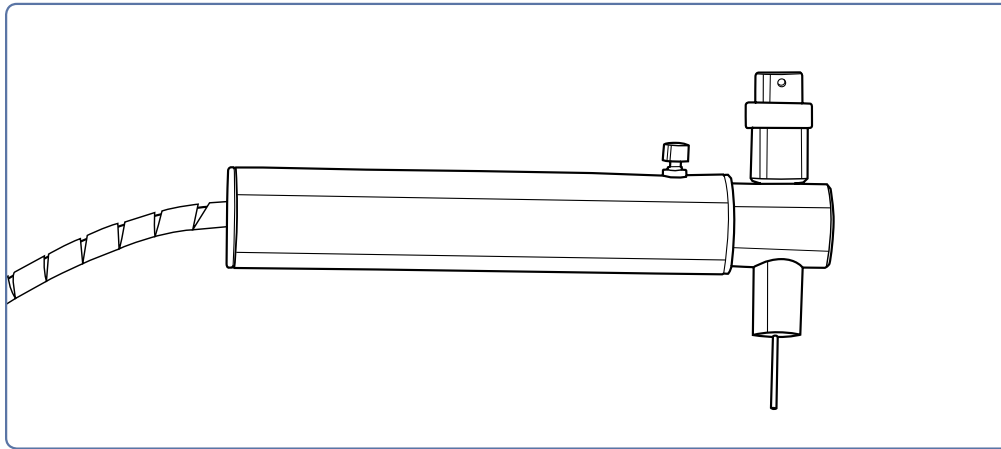

### C-5 Foot Switch

The Foot Switch allows you to operate the Microlab 600 via a foot-activated control pedal. This is useful when you need to keep both hands free, in applications such as hand sampling or animal dosing.

**Figure C-5 Foot Switch**

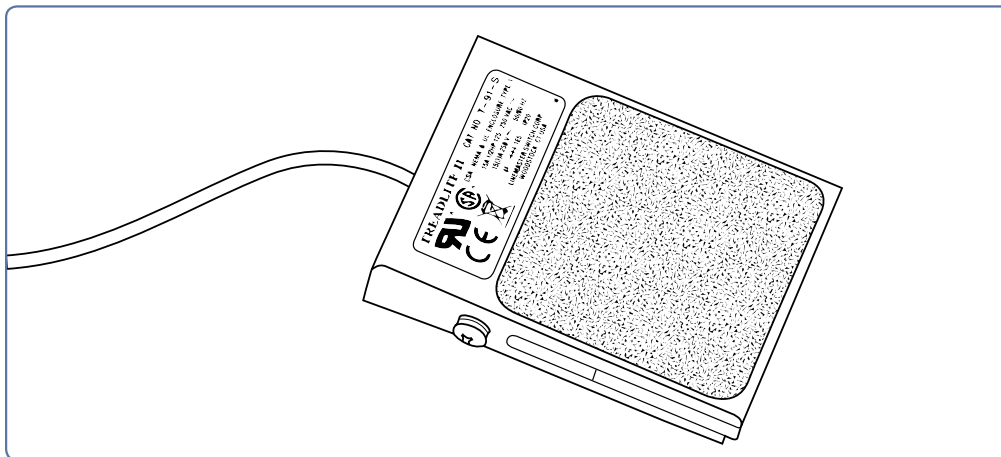



## Appendix D—Chemical Compatibility

This section contains information about chemical compatibility with the Microlab 600 instrument at room temperature. The fluid path consists of the inside syringe barrel which is made of borosilicate glass, the tip of the syringe plunger which is made of PTFE and the internal valve components which are made of PTFE and CTFE.

**Table D-1 Chemical Compatibility**

### Legend

**0** = No data available

**A** = No effect, excellent

**B** = Minor effect, good

**C** = Moderate effect, fair

**D** = Severe effect, not recommended

Chemical	PTFE	Borosilicate Glass	CTFE (Kel-F)
Acetaldehyde	A	A	A
Acetates	A	B	A
Acetic acid	A	A	A
Acetic anhydride	A	0	A
Acetone	A	A	A
Acetonitrile	A	A	A
Acetyl bromide	A	0	0
Ammonia	A	A	A
Ammonium hydroxide	A	0	A
Ammonium phosphate	A	0	A
Ammonium sulfate	A	0	A
Amyl acetate	A	A	A
Aniline	A	A	A
Benzene	A	A	B-C
Benzyl alcohol	A	A	A
Boric acid	A	0	A



Chemical	PTFE	Borosilicate Glass	CTFE (Kel-F)
Bromine	A	A-B	A
Butyl acetate	A	A	A
Butyl alcohol	A	A	B
Carbon sulfide	A	A	A
Carbon tetrachloride	A	A	B-C
Chloroacetic acid	A	A	A
Chlorine, liquid	A	A	B
Chlorobenzene	A	0	B
Chloroform	A	A	B
Chromic acid	A	A	A
Cresol	A	A	A
Cyclohexane	A	A	B
Ethers	A	A	B
Ethyl acetate	A	A	B-C
Ethyl alcohol	A	A	0
Ethyl chromide	A	0	B
Ethyl ether	A	0	A-B
Formaldehyde	A	A	A
Formic acid	A	A	A
Freon 11, 12, 22	A	A	B-C
Gasoline	A	A	A
Glycerin	A	A	A
Hydrochloric acid	A	A	A
Hydrochloric acid (conc)	A	A	A
Hydrofluoric acid	A	D	B
Hydrogen peroxide	A	A	B
Hydrogen peroxide (conc)	A	A	B

Chemical	PTFE	Borosilicate Glass	CTFE (Kel-F)
Hydrogen sulfide	A	0	A-B
Kerosene	A	A	A
Methyl alcohol	A	A	A
Methyl ethyl ketone (MEK)	A	A	A-B
Methylene chloride	A	A	B
Naptha	B	0	A
Nitric acid	A	A	A
Nitric acid (conc)	A	A-B	A-B
Nitrobenzene	A	A	A-B
Phenol	A	A	B
Pyridine	A	0	A
Silver nitrate	A	A	B
Soap solutions	A	A	A
Stearic acid	A	A	0
Sulfuric acid	A	A	A
Sulfuric acid (conc)	A	A	A
Sulturous acid	A	0	A-B
Tannic acid	A	0	A-B
Tanning extracts	0	0	0
Tartartic acid	A	0	B
Toluene	A	A	B
Trichlorethane	A	A	B
Trichlorethylene	A	A	B-C
Turpentine	A	A	A
Water	A	A	A
Xylene	A	A	B-C







## Appendix E—Instrument Performance Test Reports

The Microlab 600 is shipped with calibration certificates that validate the positional accuracy of the valve motors and syringe drives. The positional accuracy is then compared to the allowable tolerance of a 1 mL syringe to determine the resulting dispense volumes. This method has been proven to correlate to dispense accuracy through extensive testing. A white paper describing this testing can be found at [www.hamiltoncompany.com/microlab600](http://www.hamiltoncompany.com/microlab600).

Figure E-1 Example Calibration Certificate

CERTIFICATE OF CALIBRATION			
<b>Device Under Test</b> Model: ML-600 Part #: 60413-01 Serial #: ML632413 Description: ML-600 Universal Syringe Pump		<b>Calibration Device</b> Name: Mitutoyo 543-564A Model: ID-H0560 Serial No.: 001501 N.I.S.T. No.: 123456789 Accuracy: $\pm 0.0025\text{mm}$ Calibration Due: 1/15/2011	
Accuracy Specifications: $\pm 1\%$ Of Reading @ $\geq 30\%$ of Full Stroke Dispense (60mm) $\pm 1.2\%$ Of Reading @ $\geq 5\%$ to $< 30\%$ of Full Stroke Dispense (60mm) $\pm 10\%$ Of Reading @ $\leq 1\%$ to $< 5\%$ of Full Stroke Dispense (60mm)		Left Syringe Drive Calibration Result: <b>PASS</b>	
Left Syringe Drive Test Data Summary			
Command Instance	Actual 1% Stroke 0.600 mm Command	Actual 6% Stroke 3.000 mm Command	Actual 30% Stroke 18.000 mm Command
1	0.6095	3.0030	18.0018
2	0.6095	3.0030	18.0025
3	0.6100	3.0020	18.0030
4	0.6100	3.0025	18.0025
5	0.6100	3.0020	18.0030
6	0.6095	3.0030	18.0018
7	0.6095	3.0030	18.0025
8	0.6100	3.0020	18.0030
9	0.6100	3.0025	18.0025
10	0.6100	3.0020	18.0030
<b>% Allowable Precision / % Actual Precision</b>	<b>1.6% / 0.098%</b>	<b>0.5% / 0.120%</b>	<b>0.2% / 0.009%</b>
<b>% Allowable Accuracy / Actual Accuracy</b>	<b><math>\pm 1.3\%</math> / 1.607%</b>	<b><math>\pm 1.2\%</math> / 0.083%</b>	<b><math>\pm 1\%</math> / 0.014%</b>
<b>Result</b>	<b>PASS</b>	<b>PASS</b>	<b>PASS</b>
Representative Dispensed Volume, 1mL Syringe*			
Description	Actual 1% Stroke 10,000 $\mu\text{L}$ Command	Actual 6% Stroke 60,000 $\mu\text{L}$ Command	Actual 30% Stroke 300,000 $\mu\text{L}$ Command
Maximum Average Dispense ( $\mu\text{L}$ )	10.224	50.339	301.826
Minimum Average Dispense ( $\mu\text{L}$ )	10.134	49.897	299.177
<b>% Allowable Accuracy / % Dispense Accuracy @ Maximum Allowable Syringe Diameter</b>	<b><math>\pm 1.3\%</math> / 2.189%</b>	<b><math>\pm 1.2\%</math> / 0.674%</b>	<b><math>\pm 1\%</math> / 0.605%</b>
<b>% Allowable Accuracy / % Dispense Accuracy @ Minimum Allowable Syringe Diameter</b>	<b><math>\pm 1.3\%</math> / 1.322%</b>	<b><math>\pm 1.2\%</math> / -0.206%</b>	<b><math>\pm 1\%</math> / -0.275%</b>
*Representative Dispensed Volume Table is intended to extrapolate measured linear displacement data to the representative dispensed volume from a Hamilton 1mL syringe. Maximum and minimum volumes are calculated from specified syringe barrel inside diameter limits. Accuracy is shown for barrel maximum and minimum inside diameters. Complete data set for each device is on file at Hamilton Company and available upon request.			
Inspector: _____ CAROLE S. Date of Calibration: 01/21/2010			
The product specified above has been calibrated at ambient pressure. The calibration is performed pursuant to ANSI/NCSL Z-540-1-1994, with an unbroken chain of calibrations traceable to N.I.S.T.			
 <b>HAMILTON</b> THE MEASURE OF EXCELLENCE™		Hamilton Company #700 Dancy, #002, USA Tel: Free 800-448-5950 Fax: +1-773-638-7299 Telephone: +1-773-638-3000	Hamilton Branch AG P.O. Box 26 CH-7402 Bröschen/Schönenland P.O. Box 41-81-600-00-00 Telephone: +41-81-600-00-00
		 ISO 9001	PIN 2297-01 (REV. C)





# Glossary

## Accessory Holder

This is the component that attaches to either side of the Microlab 600 that holds the hand probe. See Section 2.4.4 on functionality and assembly of the Accessory Holder.

## Alarm indicator LED light

This light will illuminate on the front panel of the drive unit if a stall or other problem has occurred. See Section 2.3.1 for details.

## Aspirate

To pick up a defined volume of sample or air from the valve output port into a probe or tubing.

## Auto Refill icon

This icon can be toggled ON and OFF. When the icon is labeled ON the syringes automatically refill when they are empty. When the icon is labeled OFF the syringes will not refill until they are triggered by the hand probe or the Run icon.

## Back button

This button takes the user back to the previous screen.

## Back-off Steps

When the pump initializes its drives, the syringes move to the top of their stroke until resistance is felt. Then the pump moves back from that resistance a defined distance dictated by the Back-off Steps. This new position is set as the zero point. Some syringes have more material at the tip of their plunger so they require more Back-off Steps. The defaults should be used unless otherwise instructed by a representative of Hamilton Company or an authorized distributor for Hamilton Company.

## CAN IN and OUT (RJ-12)

The CAN IN and OUT receptacles are located on the back of the drive unit. These two ports are used for daisy chaining instruments together. Daisy chaining functionality is not supported by the Basic controller.

## Cavitation

An occurrence caused by applying a high vacuum to a liquid (gas dissolved in liquid can be pulled out of solution). It generally occurs when large syringes (5.0 to 50 mL) are driven at high speeds.



**Concorde CT Hand Probe**

The Concorde CT Hand Probe is the standard single tube hand-activated probe. The tip of the probe is adjustable and allows the user to set the dispense tubing to an angle that is comfortable for use. See Appendix C.

**Configuration screen**

This is the screen in the controller where the user can select the syringe size, valve type, triggering and system settings for the unit.

**Continuous dispenser**

An instrument that has two syringes. While one syringe is filling the other is dispensing. The Microlab 615-CNT and Microlab 625-CNT are Continuous Dispensers.

**Controller unit**

The device that allows the user to send operating instructions to the drive unit.

**Cycle**

A series of two strokes that comprise both the up and down movements of the syringe drive arm.

**Daisy chain**

A string of instruments connected in a serial configuration.

**Default**

A factory setting; for example, for each syringe size there is a default syringe speed.

**Diluent**

A liquid that is added to a sample to lessen the sample's concentration.

**Dilute**

To reduce the concentration of solutes in a sample by adding another fluid. The fluid that is added is called a diluent and may be deionized water, for example.

**Diluter**

An instrument used to reduce the concentration of a liquid. The Microlab 615-DIL and Microlab 625-DIL are Dual Syringe Diluters.

**Dispense**

To distribute fluid from a syringe in a single portion or in several increments out through the valve output port and attached tubing. Diluent is dispensed during a dilution. Reagents and buffers can be dispensed for sample preparation.



**Dispense tubing**

Tapered tubing that allows delivery of precise amounts of liquid.

**Dispenser**

An instrument used to distribute liquid. The Microlab 610-DIS and Microlab 620-DIS are Single Syringe Dispensers. The Microlab 615-DIS and Microlab 625-DIS are Dual Syringe Dispensers. The Microlab 615-CNT and Microlab 625-CNT are Continuous Dispensers.

**Display screen**

This is the touchscreen on the controller that allows the user to program and operate the instrument.

**Disposable tip**

A plastic tip used to transfer liquid which can be thrown away to avoid cross-contamination between samples.

**Down**

Describes the movement of the syringe drive arm as it moves away from the Home position and toward the bottom of the stroke.

**Down position**

This is the position of the syringe drive arms when they are fully extended away from the valve or Home position.

**Dribbling**

Describes the formation of drops at the tip of tubing as liquids are dispensed. This generally occurs when small volumes are dispensed at low flow rates or when there is an air leak in the tubing lines.

**Drive unit**

The heart of the Microlab 600 that contains the valves, syringes, tubing and the syringe drive mechanism.

**Dual dispenser**

A two syringe instrument that can dispense two different liquids at the same time. The volumes of the liquids do not have to be equal. The Microlab 615-DIS and Microlab 625-DIS are Dual Syringe Dispensers.

**Duty cycle**

The amount of time that the valve and syringe drive are active and functioning versus the time they are inactive.



## Ethernet

This is a standard communication that facilitates communication between the pump and a control device, the communication language is TCP/IP.

**⚠ WARNING!** The Microlab 600 controller is powered using Power Over Ethernet (POE) supplied from the Microlab 600 pump. When connecting the Microlab 600 pump to a computer, the POE MUST be turned Off to avoid damage to the computer. To turn the POE Off or On the Microlab 600 must first be turned Off. Next toggle the POE setting by pressing and holding the Power button for three seconds during power up. The green Ready light will flicker when POE has been turned On or will illuminate solid when POE is turned Off. The POE state will be stored in memory so the setting will remain when the instrument is turned Off and back On.

## Fill

A syringe with a volume of liquid that is pulled in from a reservoir via fill tubing through the valve input port. Drive arms move the syringes down, pulling liquid through the tubing and into the syringe.

## Fill tubing

A tubing line that connects the liquid reservoir to the valve inlet port.

## Fluid path

The inside surfaces of the valve, syringe(s) and tubing that contact liquid.

## Foot switch

A foot activated device used to trigger the Microlab 600 via the probe receptacle.

## Hand probe

See Probe.

## Hardware key

This is a Hamilton specific SD card that unlocks the advanced functionality of the pump, see the Advanced Manual (p/n 61441-01).

## Home position

See Syringe initialization

## Icon buttons

These buttons are used to provide the major navigation from function to function within the user interface.

**Initialize flow rate**

This is the same as the syringe speed however this speed is used when the pump is being initialized.

**Keypad buttons**

These buttons are used to add and clear numbers from the Value Indicator.

**Light Emitting Diode (LED)**

LED used as an indicator light on the Microlab 600.

**Alarm LED**—The Alarm LED is used to indicate when a problem arises such as a syringe stall.

**Ready LED**—The Ready LED is used to indicate the status of the pump.

**Menu**

A list of options or commands displayed on the display screen or a computer.

**Numeric keypad**

A group of keys on the controller display that are used to enter numeric data.

**Overload**

A stall of the syringe drive that may be caused by excess mechanical friction, excess syringe speed or a blockage in the valve, tubing or syringe(s).

**Parameter adjustment button**

This button shows the current dispense setting. The exact function for these buttons will be defined in greater detail in the Quick Start section of this manual.

**Pipette**

To measure a fixed amount of liquid with a probe and then dispense that same volume of liquid into a vessel.

**Power cycle**

To turn the Microlab 600 Off and then back On.

**Power down**

To turn Off an electrical device.

**Power indicator light**

An LED on the drive unit that shows whether or not the Microlab 600 system is powered on.

**Power jack (VDC Receptacle)**

This is the port where the power cord connects the drive unit or controller.



**Power On/Off button**

A button to turn the Microlab 600 On and Off.

**Prime**

The act of making the Microlab 600 ready for operation by running fluid through the fluid path (tubing, valves, syringes) to remove all bubbles. The system must be primed prior to use and between fluid changes.

**Probe**

A handheld device that enables the user to direct the fluid being moved by the Microlab 600. The probe also provides a button to trigger the operation of the pump.

**Probe receptacle**

This is the port where the hand probe or foot switch connects.

**Range indicator**

For most parameters only specific values are acceptable. The Range indicator displays the valid values for the parameter that is currently selected. If a value is entered outside of that range the font color will turn red until an allowed value is entered.

**Ready indicator light**

When the instrument is turned On and ready for use a green Ready indicator light is illuminated.

**Refill**

The syringe fill mode can be set to automatic or manual. When the Refill button is set to ON then the refill option is automatic. Likewise if the Refill button is set to OFF then the refill option is manual.

- ▶ Automatic fill mode means that the instrument will perform the fill function automatically when the method is run.
- ▶ Manual fill mode means that the instrument must be triggered using the hand probe to activate the fill function when a method is run.

**Reservoir**

A container that holds system fluid (diluent or dispense solution).

**Return Materials Authorization Number (RMA #)**

A number assigned by Hamilton Company which is used to trace an instrument in the event it is returned for repair.

### **Return Steps**

Return Steps are used to take the mechanical slack out of the syringe drive. The defaults should be used unless otherwise instructed by a representative of Hamilton Company or an authorized distributor for Hamilton Company.

### **Run screen**

This screen enables control and monitoring of all aspects of the pump's activities. Buttons and icons are used to change parameters and indicators are designed to give current and future status of the pump.

### **Serial RS-232 (DB9 female)**

The RS-232 COM port is located on the back of the drive unit. This port is used as a console port to troubleshoot connection issues encountered by the Ethernet port.

### **Single Syringe Dispenser**

A single syringe instrument that can dispense one liquid at a time. The Microlab 610-DIS and Microlab 620-DIS are Single Syringe Dispensers.

### **Small icon buttons**

These buttons provide additional functionality to the Run screen. The exact function for these buttons will be defined in greater detail in the Quick Start section of this manual.

### **Stall**

A stall of the syringe drive that may be caused by excess mechanical friction, excess syringe speed, or a blockage in the valve, tubing or syringes.

### **Step**

The smallest unit of a method, it defines what the syringes and valves will do.

### **Stroke**

Movement of the syringe drive mechanism in one direction only; half of the drive arm's cycle. See also Cycle.

### **Syringe direction indicator**

This indicator shows the direction the syringe will move in the next step. If there is not an arrow, the syringe will not be moving in the next step.

### **Syringe drive arm mechanism**

The arms to which syringe plungers connect. The movement of the syringe drive arms moves the plunger which displaces fluid, drawing it through the system.



**Syringe initialization**

Driving the syringe to the top of stroke or Home position.

**Syringe position indicator**

This indicator shows the current syringe position graphically and in a numeric volume.

**Syringe setup screen**

This is the screen where the user selects the size, speed, Return Steps and Back-off Steps.

**Syringe size**

This option allows for selection of syringes between 10  $\mu\text{L}$  and 50 mL. Once a syringe size is selected, the controller will automatically set the Syringe Speed, Return Steps and Back-off Steps to the recommended value.

**Syringe speed**

The syringe speed is programmed in flow rate ( $\mu\text{L}/\text{sec}$ ). The default setting for speed will be automatically selected when the Syringe Size is changed. When changing the Syringe Speed the system will recommend two alternative speeds in addition to the default speed. If none of the speeds are desirable, select the custom option to define a new flow rate. If the speed selected is faster than the default it may cause the instrument to stall. The allowable flow rates are displayed in Table 2-5.

**System fluid**

Refers to the fluid originating from a reservoir, pumped through the entire system.

**Trigger screen**

This is the screen where the user selects whether the pump is to be triggered from the left, right or either.

**Tubing clip**

A device that attaches to the side of the reservoir that holds tubing lines in place.

**Value indicator**

This indicator displays the current value that will be stored when the Enter button is pressed.

**Valve**

The device that directs the flow of liquid through the system.

**Valve drive motor**

The valve drive motor is part of the drive unit that controls valve rotation.

**Valve initialization**

Valves rotate more than 360 degrees to identify a calibration location on the optical encoder. When this location is identified the exact valve location is known.

**Valve move indicator**

This indicator shows the current valve position and the position where the valve will move in the next step. If the indicator says “Ready” the valve will not move in the next step.

**Valve port**

Openings in the valve assembly through which liquid flows. As the valve turns, ports are opened or closed, directing the flow of liquid through the system.

**Valve position indicator**

This indicator shows the current valve position and the fluid path. For more details, see Section 3.3.1.

**Valve setup screen**

This is the screen where the user selects what type of valve is on the left and right side of the instrument.

**Viscosity**

A property of liquid and it's resistance to flow. Alcohol for example, has a very low viscosity, whereas molasses has a very high viscosity.







# Index

## A

Accessory Holder .....	2-7, 2-8, 2-19–2-21, B-3, GL-1
Auto Refill icon .....	3-3, GL-1

## B

Back button .....	3-3, GL-1
Back-off Steps.....	4-3, GL-1
Batteries.....	5-4

## C

CAN IN/OUT .....	2-7, 2-8, GL-1
Chemical compatibility .....	D-1–D-3
Cleaning	
Exterior .....	5-4
Fluid Path.....	5-3, GL-4
ClickSure® tips .....	C-1
Concorde CT Hand Probe.....	2-3, 2-19, B-2, C-1–C-2, GL-2
Configuration screen.....	GL-2
Continuous dispense kit .....	2-2–2-3
Continuous dispenser .....	1-5, 2-19, 2-24, 3-5, 4-9, B-3, GL-2
Continuous fill tubing .....	2-3, 2-19, B-3
Controller unit	
Description .....	2-22–2-23, 4-4–4-6, B-1, GL-2
Ethernet receptacle .....	2-23

## D

Daisy chaining .....	2-8, GL-2
Data entry screen .....	3-6
Device expansion.....	2-23



Diluter .....	1-4, 2-17, 2-24, 3-4, 4-8, GL-2
Diluter kit .....	2-2-2-3
Dispense kit.....	2-2-2-3
<b>Dispensers</b>	
Dual Syringe .....	1-4-1-5, 2-17-2-19, GL-3
Single Syringe .....	1-3, 2-17, GL-3
<b>Disposable Tip Hand Probe.....</b>	<b>C-1, C-3, GL-3</b>
<b>Drive unit</b>	
Description .....	2-4-2-8, GL-3
Installation of components.....	2-9-2-20
<b>Dual Push Button Probe.....</b>	<b>2-3, C-1-C-2</b>
<b>Dual Syringe Continuous Dispenser .....</b>	<i>See</i> <b>Continuous dispenser</b>
<b>Dual Syringe Diluter.....</b>	<i>See</i> <b>Diluter</b>
<b>Dual Syringe Dispenser.....</b>	<i>See</i> <b>Dispensers</b>
<b>E</b>	
<b>Error code guide .....</b>	<b>6-2</b>
<b>Ethernet.....</b>	<b>2-7, 2-22-2-23, GL-4</b>
<b>F</b>	
<b>Foot switch .....</b>	<b>2-21, C-1, C-4, GL-4</b>
<b>H</b>	
<b>Hand probe receptacle .....</b>	<b>2-4, 2-5, 2-21</b>
<b>Hardware configuration.....</b>	<b>4-2-4-3</b>
<b>Hardware key .....</b>	<b>2-23, GL-4</b>
<b>Host USB Port .....</b>	<b>2-23</b>
<b>I</b>	
<b>Icon screens .....</b>	<b>3-2</b>
<b>Installation</b>	
Accessory Holder.....	2-19-2-21

Electrical connections .....	2-21–2-22
Hand probe .....	2-21
Syringes.....	2-11–2-14
Tubing.....	2-15–2-18
Valve assemblies.....	2-9–2-11
<b>Instrument configuration.....</b>	<b>1-3–1-5, 2-17–2-19</b>
<b>K</b>	
<b>Keypad buttons.....</b>	<b>3-7, GL-5</b>
<b>L</b>	
<b>Language .....</b>	<b>4-6</b>
<b>Large Volume Disposable Tip Hand Probe.....</b>	<b>C-1, C-4</b>
<b>LED lights</b>	
Alarm .....	2-6, GL-1
Power.....	2-6, GL-5
Ready .....	2-6
Syringe selector .....	2-6
<b>Light Emitting Diode.....</b>	<b>GL-5</b>
<b>M</b>	
<b>Manual conventions .....</b>	<b>7</b>
<b>N</b>	
<b>Numeric keypad .....</b>	<b>3-7, GL-5</b>
<b>O</b>	
<b>Operation .....</b>	<b>1-6</b>
<b>Overview of the Microlab 600.....</b>	<b>1-2–1-6</b>
<b>P</b>	
<b>Parameter adjustment button.....</b>	<b>3-3, GL-5</b>
<b>Performance test reports .....</b>	<b>E-1</b>



<b>Pop-up Control</b> .....	<b>3-6</b>
<b>Power cord</b>	
Description .....	B-4–B-5
Safety .....	1-6
<b>Power On/Off</b> .....	<b>2-4–2-6, GL-6</b>
<b>Power over Ethernet</b> .....	<b>2-7, GL-4</b>
<b>Preparing the syringes</b> .....	<b>2-13</b>
<b>Prime button</b> .....	<b>2-4, 2-5, 2-6</b>
<b>Priming the instrument</b> .....	<b>4-7</b>
<b>Probe receptacle</b> .....	<b>2-4, 2-5, GL-6</b>
<b>Probes</b> .....	<b>2-21, C-1–C-4, GL-6</b>
<b>Q</b>	
<b>Quick Start</b> .....	<b>4-8–4-9</b>
Continuous Dispenser.....	4-9
Dual Syringe Diluter.....	4-8–4-9
Dual Syringe Dispenser.....	4-9
Single Syringe Dispenser .....	4-8
<b>R</b>	
<b>Range indicator</b> .....	<b>3-7, GL-6</b>
<b>Replacement parts</b>	
ClickSure tips .....	C-1
Hand probes.....	C-1–C-4
Power cords .....	B-5
Power supply.....	B-4
Syringes.....	B-1
Tubing.....	B-2
Valves .....	B-2
<b>Return Materials Authorization (RMA) number</b> .....	<b>5-2, GL-6</b>
<b>Return Steps</b> .....	<b>4-3, GL-7</b>
<b>Run screen</b> .....	<b>3-3–3-4, GL-7</b>

**S**

<b>SD card</b> .....	<i>See</i> <b>Hardware key</b>
<b>Selecting</b>	
Instrument location .....	1-5, 2-4
Syringes.....	2-11–2-12
Tubing.....	2-15
<b>Serial RS-232</b> .....	<b>2-7, 2-8, GL-7</b>
<b>Servicing the instrument</b> .....	<b>6-4–6-5</b>
<b>Setting syringe volumes</b> .....	<i>See</i> <b>Instrument configuration</b>
<b>Single Syringe Dispenser</b> .....	<i>See</i> <b>Dispensers</b>
<b>Slave USB Port</b> .....	<b>2-23</b>
<b>Small icon buttons</b> .....	<b>3-3, GL-7</b>
<b>Software CD</b> .....	<b>2-3, B-1</b>
<b>Software configuration</b> .....	<b>4-4–4-7</b>
<b>Splash screen</b> .....	<b>3-2</b>
<b>Storing the instrument</b> .....	<b>5-4</b>
<b>Syringe direction indicator</b> .....	<b>3-3, 3-4, GL-7</b>
<b>Syringe drive</b> .....	<i>See</i> <b>Drive unit</b>
<b>Syringe position indicator</b> .....	<b>3-3, GL-8</b>
<b>Syringes</b>	
Cleaning .....	5-3–5-4, B-2
Installing .....	2-11–2-14
Preparation for installation .....	2-13
Selecting.....	2-11–2-12
<b>Syringe selector button</b> .....	<b>2-5, 2-6</b>
<b>Syringe setup</b> .....	<b>4-2–4-3</b>
<b>Syringe size</b> .....	<b>2-11, 2-12, B-1</b>
<b>Syringe speed</b> .....	<b>2-11, GL-8</b>
<b>System</b>	
Overview.....	1-2–1-6, 2-2–2-3



<b>T</b>	
Technical specifications .....	A-1
Technical support .....	4-10, 6-4
Touchscreen interface .....	<i>See</i> <b>Controller unit</b>
Triggering.....	4-3
Troubleshooting .....	6-2-6-5
TTL IN/OUT .....	2-7, 2-8
<b>Tubing</b>	
Cleaning .....	5-3-5-4
Continuous dispense .....	2-3, B-3
Dispense.....	2-3, B-2, GL-3
Fill .....	2-3, B-2, GL-4
Installing .....	2-15-2-19
Replacing .....	B-2-B-3
Selecting.....	2-15
<b>Tubing Management System</b> .....	2-20-2-21
<b>U</b>	
Universal power supply.....	B-4
<b>Universal valve</b>	
Installation .....	2-9-2-11
Replacement .....	B-2
<b>Update</b> .....	4-10
<b>Upgrade kits</b> .....	2-3, B-1
<b>USB adapter</b> .....	2-3, B-1
<b>User interface</b> .....	4-2
<b>Utilities</b> .....	4-9-4-10
<b>V</b>	
Value indicator .....	3-7, GL-8
Valve .....	<i>See</i> <b>Universal valve</b>
Valve actuator.....	2-4, 2-5, 2-9

<b>Valve move indicator .....</b>	<b>3-3, 3-4, GL-9</b>
<b>Valve position indicator.....</b>	<b>3-3, 3-4-3-5, GL-9</b>
<b>Valve setup.....</b>	<b>4-3</b>



HAMILTON



© 2013 Hamilton Company. All rights reserved.  
All trademarks are owned and/or registered by  
Hamilton Company in the U.S. and/or other countries.  
Part. No. 61440-01 (Rev. F)

**HAMILTON** 

Distributed by:

**Lab Unlimited**  
CARL STUART GROUP

Tallaght Business Park  
Whitestown, Dublin 24,  
Ireland  
D24 RFK3

Tel: (01) 4523432  
Fax: (01) 4523967  
E-mail: [info@labunlimited.com](mailto:info@labunlimited.com)  
Web: [www.labunlimited.com](http://www.labunlimited.com)

Quatro House, Frimley Road,  
Camberley,  
United Kingdom  
GU16 7ER

Tel: 08452 30 40 30  
Fax: 08452 30 50 30  
E-mail: [info@labunlimited.co.uk](mailto:info@labunlimited.co.uk)  
Web: [www.labunlimited.co.uk](http://www.labunlimited.co.uk)